

PHYSICS

CHEMISTRY
BIOLOGY

ENGINEERING



LD DIDACTIC

COMMUNICATIONS TECHNOLOGY



CATALOG T7

LEYBOLD®

Content

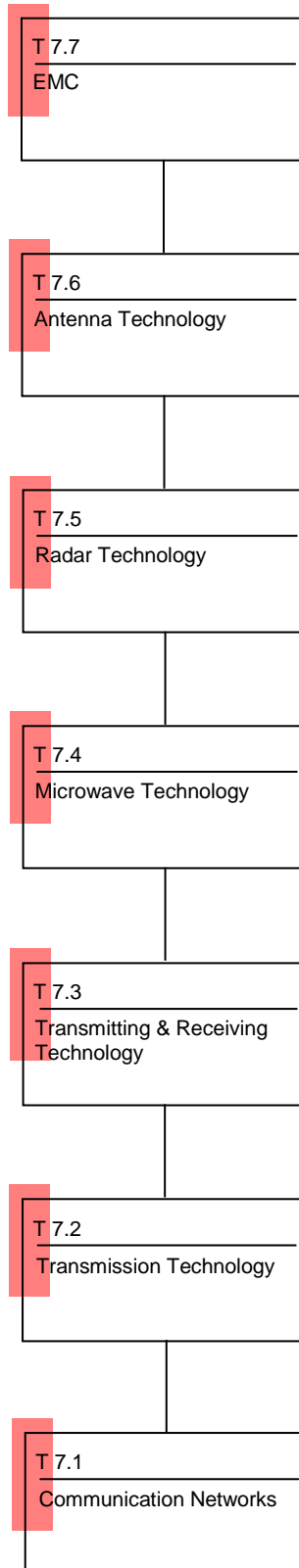

Content

Communications Technology

Vocational training in IT technology needs to qualify students in wide spread topics such as: modulation, coding, lines, services, protocols, antennas, RF technology, radar etc. In this wide field the communication technology from LD Didactic is tailored to the needs of state of the art training. The *T 7 Communications Technology* catalog shows the total scope of training systems for aspects of telecommunication. The equipment sets contain material for the training of the basics and for more sophisticated experiments. Experiments are carried out either by means of training panels or with multimedia courses.

Training Systems	4
Technical Details	6
Communication Networks	9
Transmission Technology	25
Transmitting & Receiving Technology	59
RF Technology	63
Microwave Technology	68
Radar Technology	95
Antenna Technology	109
Electromagnetic Compatibility	123
Accessory	129
Equipment Sets	133
Keywords	155

Symbols and abbreviations used in this catalog:

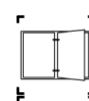

Experiment manuals contained



Software contained



Accessory required



Battery required



Compatible to COM3LAB



USB support



Mind mains voltage

Training Systems

Training Panels

The training systems in this catalog make use of training panels and of multimedia-courses.

TPS - Training Panel System

This training system on the base of experimental panels offers a lot of advantages in lab work and in demonstration lessons:

- Clear representation
- Block diagrams and circuit elements according to DIN and IEC
- Connection realized by 19 mm plugs
- Industrial subsystems and components for realistic results
- Security sockets and cables
- High degree of compatibility to the training systems STE/SIM and COM3LAB



TPS-units consist of a front panel and PCB-board and a back cover. The panels are easily placed in a mounting frame. Thus simply configuration and alteration in the experiment setup are possible.



Training Systems

COM3LAB-Multimedia



Theory and practice merged into one package

COM3LAB is used in the vocational training of electrical engineering and electronics. COM3LAB acts as the interface between theory and practice. Thus COM3LAB not only conveys theoretical aspects of the subject matter, but at the same time deepens and consolidates this knowledge by real experiments. COM3LAB consists of a Master Unit and various individual courses (experiment board + CD-ROM). The Master Unit is the basic device through which the software and experiment board communicate with each other. More information for the COM3LAB components shown in this catalog can be found in the COM3LAB-System-catalog.



Master unit

Experimentation board

CD-ROM

Technical Details

CASSY-Interfaces and CASSY Lab 2

The CASSY family consists of various hardware components and the dedicated software package CASSY Lab 2



524 013 Sensor-CASSY 2

Sensor-CASSY 2 is a cascadable interface for data recording. It has galvanic separated inputs and automatic sensor box recognition by CASSY Lab (plug and play). Sensor-CASSY 2 is the interface with enhanced measurement ranges for:

- T 7.2 Transmission Technology
- T 7.4 Microwave Technology
- T 7.5 Radar Technology



Technical Details

CASSY Lab 2

CASSY Lab 2 is a modern 32-bit software, applicable for Windows XP/Vista/7 with the following features:

- Data recording
- Multimeter
- Oscilloscope
- XY-plotter
- FFT-analysis
- Variety of evaluation aids
- Export of measurement data and diagrams

Sensor-CASSY 2 is a versatile measurement instrument and data logger for experiments in telecommunication technology. Together with the software CASSY Lab it is possible to perform the following tasks:

- Measurements in the time domain (oscilloscope)
- Measurements in the frequency domain (spectrum analyzer)
- Recording of characteristics in XY-representation
- Export and post processing of measurements with external software.

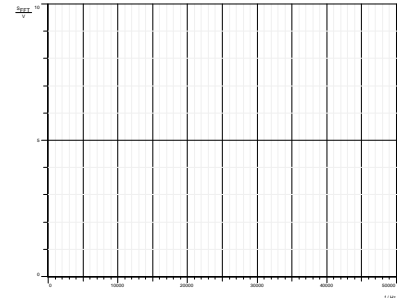

CASSY Lab 2
Measurement of the spectrum of a square wave

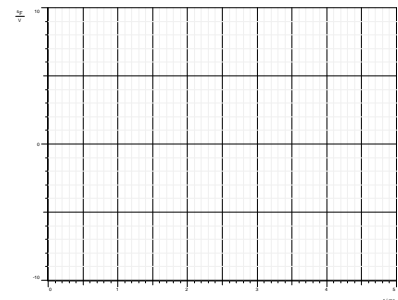

CASSY Lab 2
Measurement of the time response of a pulse train

SOFTWARE PACKAGE

CASSY Lab

Cat.-no	Description	Content
524 220	CASSY Lab 2	Software for recording and evaluation of measurement data of the CASSY-interface family with extended integrated help

Note: The software CASSY Lab 2 is already contained in the scope of delivery in the *Starter Packages* e.g. in 524 013S Sensor-CASSY 2 Starter.

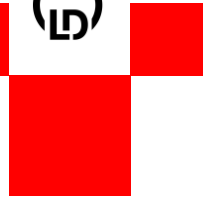

T 7.1 Communication Networks



T 7.1 Communication Networks

Equipment Sets

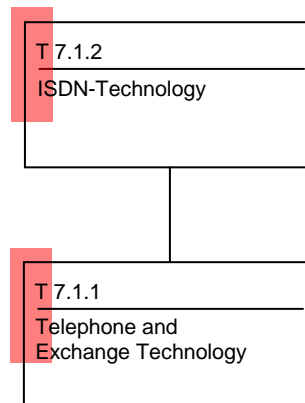

The training system *Telephone and Exchange Technology* offers an unsurpassed multitude of topics.

Topics (complete list)

- Switching networks and direct connections
- ISO /OSI Model
- Switching and ISDN
- Services in the telephone network
- Voice and noise
- Investigation of the speech signal
- Measurement of the reverse loss
- Digitalization of the telephone signal
- Sampling of the voice signal
- Companding
- BORSCHT
- Classic telephone systems
- Basics of installation technology
- Switching systems with directly controlled selectors
- Pulse dialing / multi frequency dialing
- Spectral analysis of the DTMF signaling
- Realization of the of the telephone set
- Signaling
- Digital switching systems
- Functional units of exchange systems
- Subscriber matching unit
- Multiplexer / demultiplexer
- Space switches and stages
- Time switches and stages
- Control memories
- Information memories
- The coupling point matrix
- The TST-Network
- Digital switching in local nets
- Speech path selection and speech path latching
- Blocking in the TST net
- Operating a TST net
- EWSD and S12
- Switching scenarios and protocol analysis
- Establishing of service features
- Digital switching in trunk systems
- VoIP
- Network management
- Subscriber listing
- DECT
- Basics of fax transmission

T 7.1 Communication Networks

Equipment Sets

LD-Training systems for communication networks are well suited for student projects. In an existing network (LAN) the COM3LAB-software *LETS* is installed. The Telephone Switching Modules (735 801) from *T 7.1.1 Telephone- and Exchange Technology* are connected to the dedicated PC. With the PC embedded in the local net, the software LETS of the exchange system can be operated in local and in trunk connection. The communication between the PC is realized by an IP protocol. The interaction of training systems for exchange telephony and network installation integrates even actual technology with commercial interest for future VoIP applications.



T 7.1.1 Telephone and Exchange Technology

Exchange technology controls the access to the transmission channels. For practical and economical reasons, worldwide communication requires a concentration on the data highways and an expansion of the subscriber lines at the destination.

T 7.1.2 ISDN-Technology

Even in ISDN communication exchange systems are indispensable. Thus knowledge about the basic principles of digital exchange technology is important for technicians responsible for installation and maintenance of any kind of IT systems.

T 7.1.1 Telephone and Exchange Technology

Equipment Sets

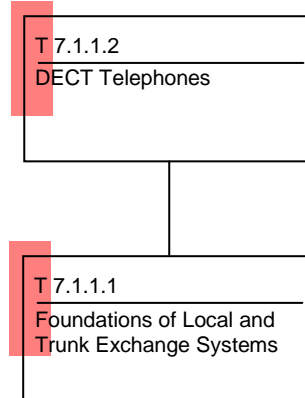

Four telephone switching modules from the basic equipment set make the powerful hardware core of the training system. Even without the multimedia training software you can follow the switching process in a step-by-step mode, displayed by the LEDs and subscriber numbers on the TSM. Visible are the activation of speech- and dialing signals, the release of the *ab*-port, the calling subscriber respectively the called subscriber and the speech signals behind the hybrid circuit.

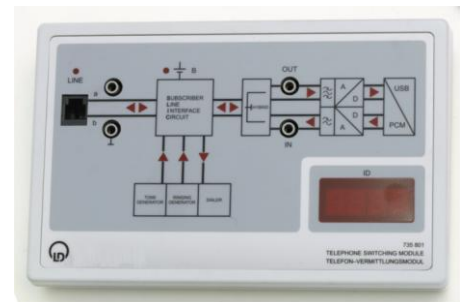

Telephone Switching Module (TSM)

Even a glance back to the mechanical ancestors is possible by means of a multimedia-based animation. Switching then was a pure spatial process that was carried out by motor selectors. The figure shows the contact bank of a so-called EMD-selector. To go deeper into the theory of switching, the concept of coupling point matrices is developed.

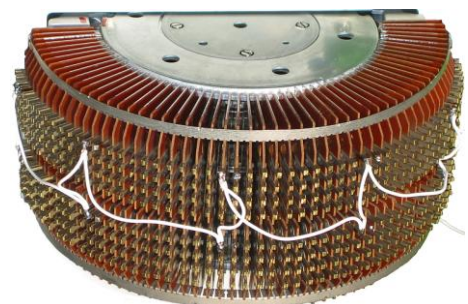

History: Directly controlled motor selector

T 7.1.1 Telephone and Exchange Technology

Inside the TST Switching Matrix

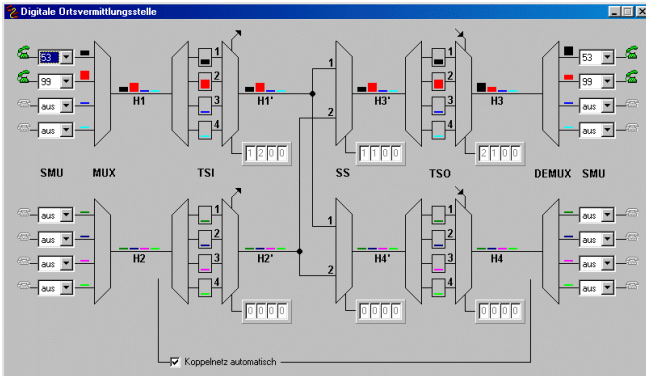

The switching system in Time-Space-Time configuration can be operated either automatically or manually. Even blockings can be provoked and are investigated in detail. The volume of the voice channels is represented by colored amplitude bars.

Switching System

The manual mode of operation by far surpasses the possibilities of traditional fault simulators! In our system it is not necessary to simulate faults. Students who don't know the algorithm of the speech path allocation and selection will not be able to get their speech channel properly connected. Colored amplitude bars individually indicate the strength of the voice signals.

Subscriber Matching Unit

Noise measurements with integrated noise generator and band pass filter. The subscriber matching unit gives access to different modes of quantisation as well as the allocation of services features.

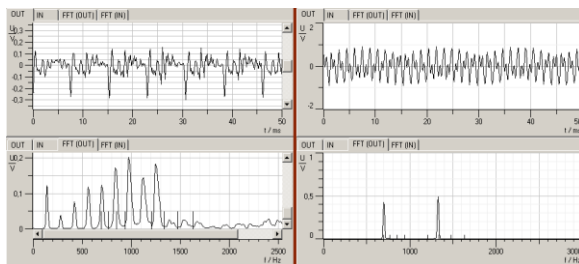
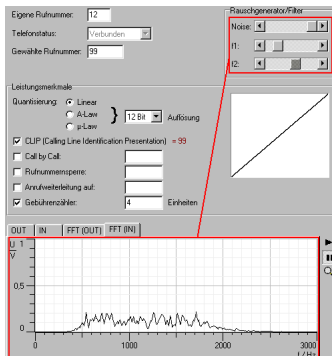

Voice signal analysis

Voice signal analysis with the integrated measurement instruments oscilloscope and FFT analyzer. Of interest is the investigation of the DTMF signaling with the FFT analyzer.

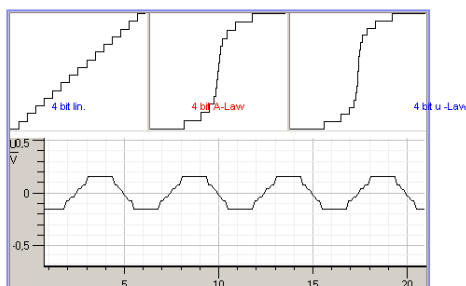

Quantisation

The differences between linear quantisation and the characteristics according to A-law and μ -law are especially perceivable at low resolutions of the AD-converters (4 bit).

T 7.1.1 Telephone- and Exchange Technology

T 7.1.1.1 Foundations of Local and Trunk Exchange



Experiment setup with switching module and telephone

Topics (selection)

- Telephone sets
- Digitalization of the voice signal
- Exchange systems
- Speech path allocation
- Establishing service features
- Net management

T 7.1.1 Telephone and Exchange Technology

T 7.1.1.1 Foundations of Local and Trunk Exchange Systems

The training system gives deep insight into modern telephone systems and switching technology. Emphasis is laid on the processing of time division multiplex signals in local and trunk exchange systems, implementing service features and the voice signal coding. But the scope of topics is much more extended: even the classic principles with motor selectors, the trunk exchange and communication via VoIP are discussed. The guidance into the world of exchange systems is carried out by a multimedia training software. Experiments make use of integrated software tools. The software controls the switching modules with an propriety protocol, it carries out the switching process and explains the experiments. The switching net can be operated manually and automatically.



Complete compact and computerized. The sophisticated COM3LAB course: Foundations of Local and Trunk Exchange Systems is delivered in a practical storage case.

EQUIPMENT LIST T 7.1.1.1

735 800 Foundations of Local and Trunk Exchange Systems

Quantity	Description
4	Telephone Switching Module
4	Telephone Set, analog, RJ12
1	CBT Exchange Software LETS
1	Case

A complete material list including accessories is available on request. **LETS** is the abbreviation for **LD Exchange Technology System**.

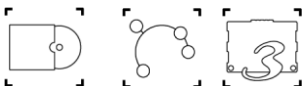

T 7.1.1 Telephone - and Exchange Technology

T 7.1.1.2 DECT Telephones

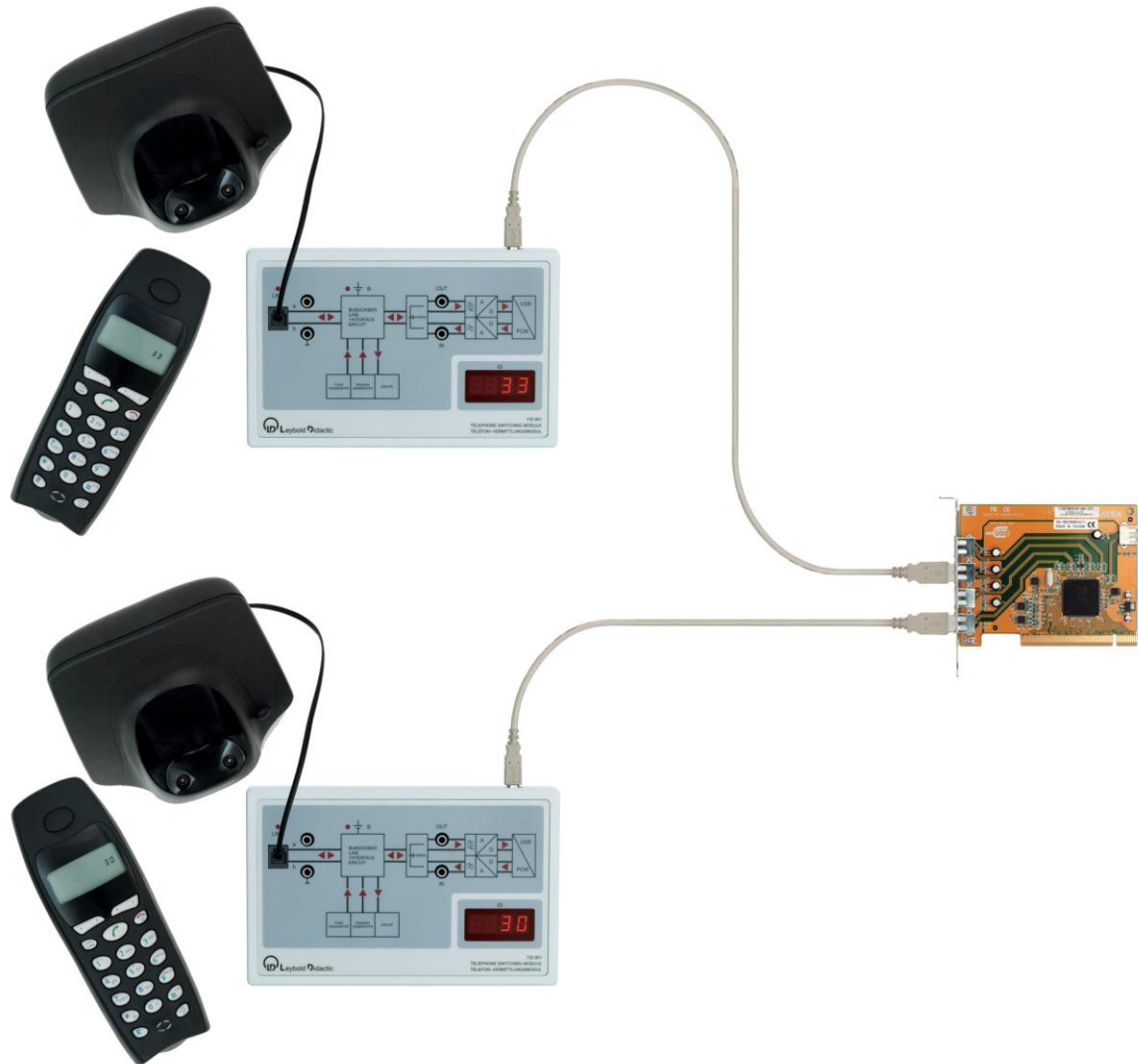

Experiment setup with telephone switching module and telephone set

Topics (selection)

- Telephones according the DECT standard
- Call establishing
- Net management

T 7.1.1 Telephone - and Exchange Technology

T 7.1.1.2 DECT Telephones

Multimedia effects support evaluation and interpretation of the results in both equipment sets (T 7.1.1.1 and T 7.1.1.2). Each telephone is connected to the PC via USB using its own Telephone Switching Module (735 801). Each Telephone Switching Module contains:

- DC-Power supply for the terminal equipment
- Activation of signaling
- Digitized hybrid circuit
- Microprocessor control
- Measurement modules for sampling the speech signals and the signaling

Using several equipment sets or supplements, hierarchical structured switching systems can be established and investigated. Together with a commercial LAN, a real communication net with different traffic nodes can be realized.



The equipment set DECT can be combined with 735 800 Foundations of Local and Trunk Exchange Systems.

EQUIPMENT LIST T 7.1.1.2

735 805 DECT Telephones

Quantity	Description
2	Telephone Switching Module
2	DECT Telephone
1	CBT Exchange Software LETS
1	Case

A complete material list including accessories is available on request. **LETS** is the abbreviation for LD Exchange Technology System.



T 7.1.2 ISDN Technology

Equipment Sets

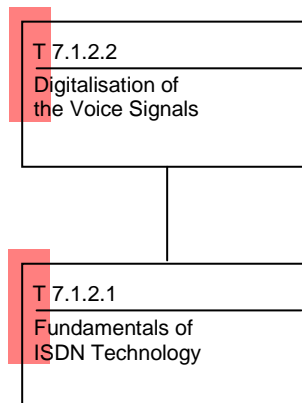

The training system *ISDN Technology* covers a multitude of topics.

Topics (complete list)

- Basics
- ISDN–Interfaces
- Internal interfaces of a PABX system
- Internal S0 bus
- MSN - Multiple Subscriber Number
- Calling Line Identification Representation
- Calling Line Identification Restriction
- Installations at the basic access terminal
- Network terminal basic access NTBA
- Power supply
- Standard operation
- Emergency operation
- Installation for the basic access: point to point and point to multipoint
- Short / extended passive bus
- Wiring
- OSI reference model
- Configuration of the devices
- Installation errors
- Swapped terminals
- Resistance and wiring measurements
- Data transfer on the physical Layer
- Services and features in the ISDN
- Connection testing
- Test of services
- Testing of individual services
- Service feature *Hold*
- CLIP
- CLIR
- D-channel protocol
- Establishing and ending of connections on the D-channel
- Testing a feature with the help of D-channel information

T 7.1.2 ISDN Technology

Equipment Sets

T 7.1.2.1 Fundamentals of ISDN Technology

The net provider is responsible for the hard- and software of the switching system and the subscriber lines up to the NTBA (interface: Network Termination Basic Access). While these parts of the system are out of reach, indoors the S0 bus can be examined with this training system. ISDN (Integrated Services Digital Network) gives more power and a unified transmission form for the different services. This is the prerequisite to combine even so different services as voice, text, video, and data within only one net. Classic analogue systems (POTS **P**lain **O**ld **T**elephone **S**ystems) by far need more effort to handle the subject. The training system *T 7.1.2 ISDN Technology* is a versatile combination of commercial equipment and didactical components. It will guarantee hands on skills.



T 7.1.2.2 Digitalisation of the Voice Signals

Using the components of the training system *T 7.2.2.1 Pulse Code Modulation*, a modern self contained system is available, which due to two time multiplex channels perfectly satisfies ISDN requirements. It facilitates elaborate experiments and should not be missing in a lab for communications networks. Content and description can be found on page 36 of this catalog.



T 7.1.2 ISDN Technology

Description

Basic System

In order not to jeopardize the operational safety of public networks, the LD Didactic ISDN training system employs a digital exchange with two internal S_0 buses as the switching center. Hence, data exchange of practical relevance between the terminal equipment can be examined without an external public exchange connection. Monthly fees for connection to the network are not incurred.

ISDN-Access-Panel

Terminal equipment, ISDN testers and oscilloscope are connected to the digital exchange via an access panel and are capable of intercommunication. The bit transmission layer of the S_0 frame can be displayed on the oscilloscope. Communication between the terminal equipment may be impaired by means of an integrated noise source (BER test). In a 4-mm socket terminal, the installation of S_0 buses and the wiring may be checked.

Telephones

The training system supports all important service characteristics, e.g.: display of calling party's call number (CLIP), call waiting (CW), re-plugging of terminals at bus (TP), etc. The ISDN tester can be used to accurately determine all possible current service characteristics.

Measurement Technology

Special attention is given to straightforward, menu-driven operation of the ISDN tester (735916). The protocol can be interpreted via the internal analyzer display or via PC. In addition to D-channel analysis, the instrument is also capable of determining services and service characteristics, and of checking bus wiring for crossed lines, levels, feed voltages, terminations etc.

T 7.1.2 ISDN Technology

Description

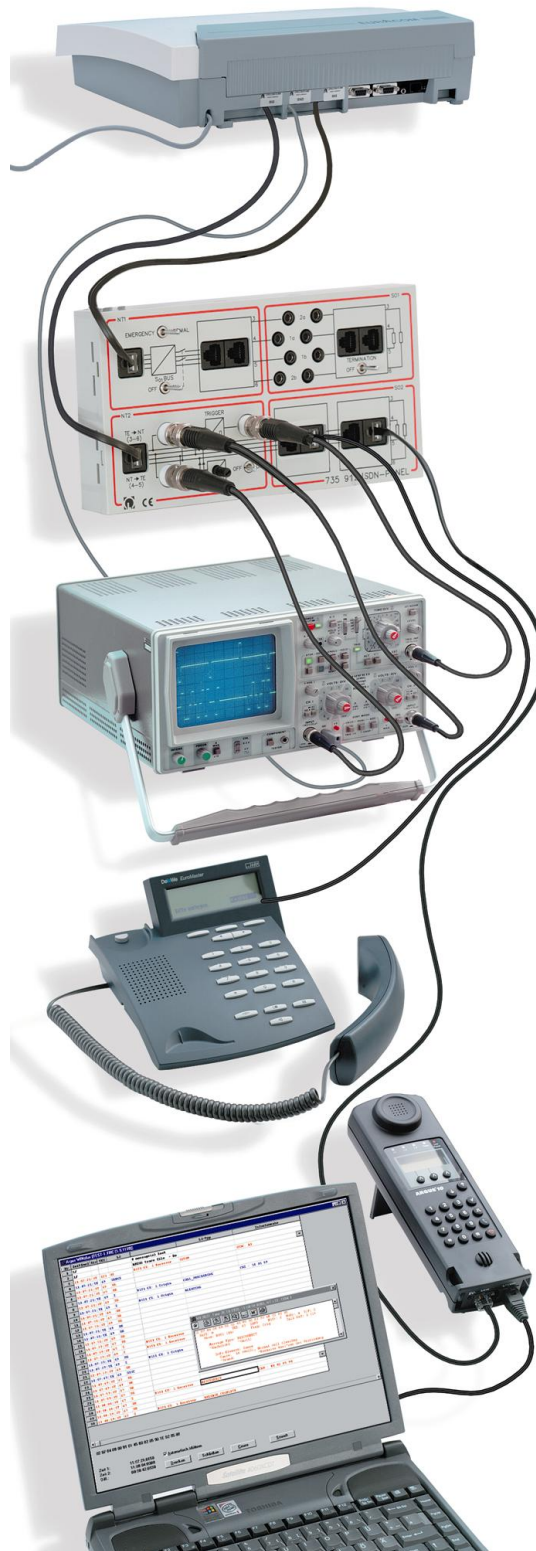

Example for an experiment setup

T 7.1.2 ISDN Technology

T 7.1.2.1 Fundamentals of ISDN Technology



Topics (selection)

- ➔ Configuration of the PABX
- ➔ Wiring errors
- ➔ Data transmission on the S0 bus
- ➔ Services and features

T 7.1.2 ISDN Technology

T 7.1.2.1 Fundamentals of ISDN Technology

Running at a transmission speed of 64 kBit/s many services are faster in ISDN and therefore more economical than in Plain Old Telephone Systems (POTS). But the integration of the services into a common net has even more advantages: With a basic ISDN access it is possible to run up to 8 different devices with the same subscriber number. It is possible to make a telephone call while the fax machine is active.

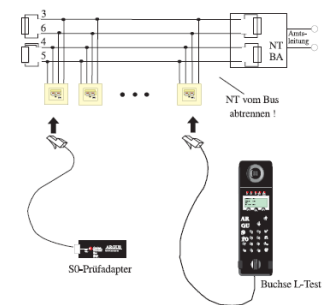

Detection of line crossing at the S0-bus

The cat. no. *735 900 Fundamentals of ISDN Technology* is a course containing all ISDN specific components. Accessories e.g. measuring instruments, oscilloscope, cables etc. are not included in the package.

EQUIPMENT LIST T 7.1.2.1

735 900 Fundamentals of ISDN Technology

Quantity	Description
1	ISDN-Panel
1	PABX-System
3	ISDN-Telephone
1	ISDN-Tester

A complete material list including accessories is available on request.

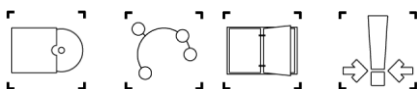

The content of the equipment set *T 7.1.2.2 Digitalisation of the Voice Signal* is equal to *T 7.2.2.1 Pulse Code Modulation*. Please refer to page 36 for details.

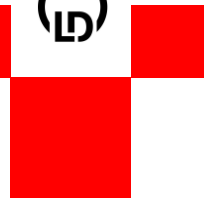

T 7.2 Transmission Technology



7.2 Transmission Technology

Equipment Sets

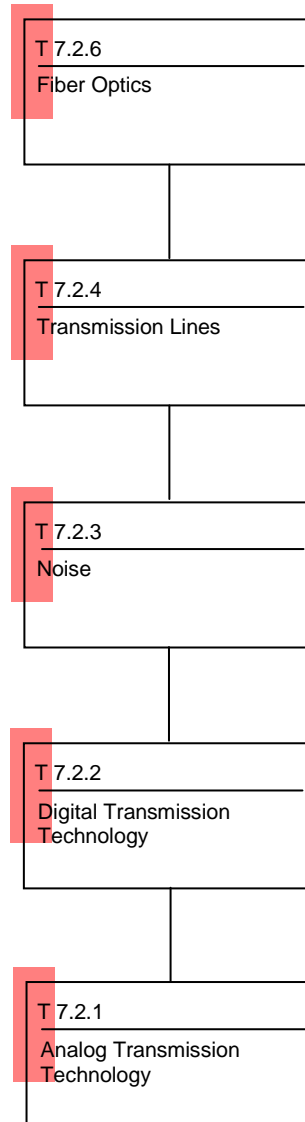

T 7.2 Transmission Technology

Equipment Sets

The efficient use of data transmission systems with cables, radio- and satellite links, requires methods for the simultaneous use of numerous message channels. Message signals are mostly at low frequencies and have to be modulated on higher carrier frequencies. This can be done by means of analog or digital modulation methods.

T 7.2.1 Analog Transmission Technology

The foundations are discussed with these courses: signal analysis according Fourier, classic modulations AM and FM. Emphasis is laid on the recording and evaluation of oscillograms and spectra.

T 7.2.2 Digital Transmission Technology

These courses investigate experimentally the features of pulse modulations. Hands on practice is guaranteed by using commercial circuitry. The frequency bands are in accordance to the CCIT standards.

T 7.2.3 Noise

On the transmission channel, the wanted signal is superimposed by distortions and noise. It is an important aspect of modulation to minimize the influence of disturbances on the wanted signal.

T 7.2.4 Transmission Lines

There is a huge number of different line types used in line-bound telecommunications. By exploiting various physical properties, these transmission lines effectively transmit information across long distances.

T 7.2.6 Fiber Optics

Modern line-bound telecommunication is increasingly using dielectric lines as the transmission medium of choice. The lines are called optical fibers and have an enormous transmission capacity, which is well-suited for the rapidly growing needs of world-wide communications.

T 7.2.1 Analog Transmission Technology

T 7.2.1.2 Fourier-Analysis and Synthesis

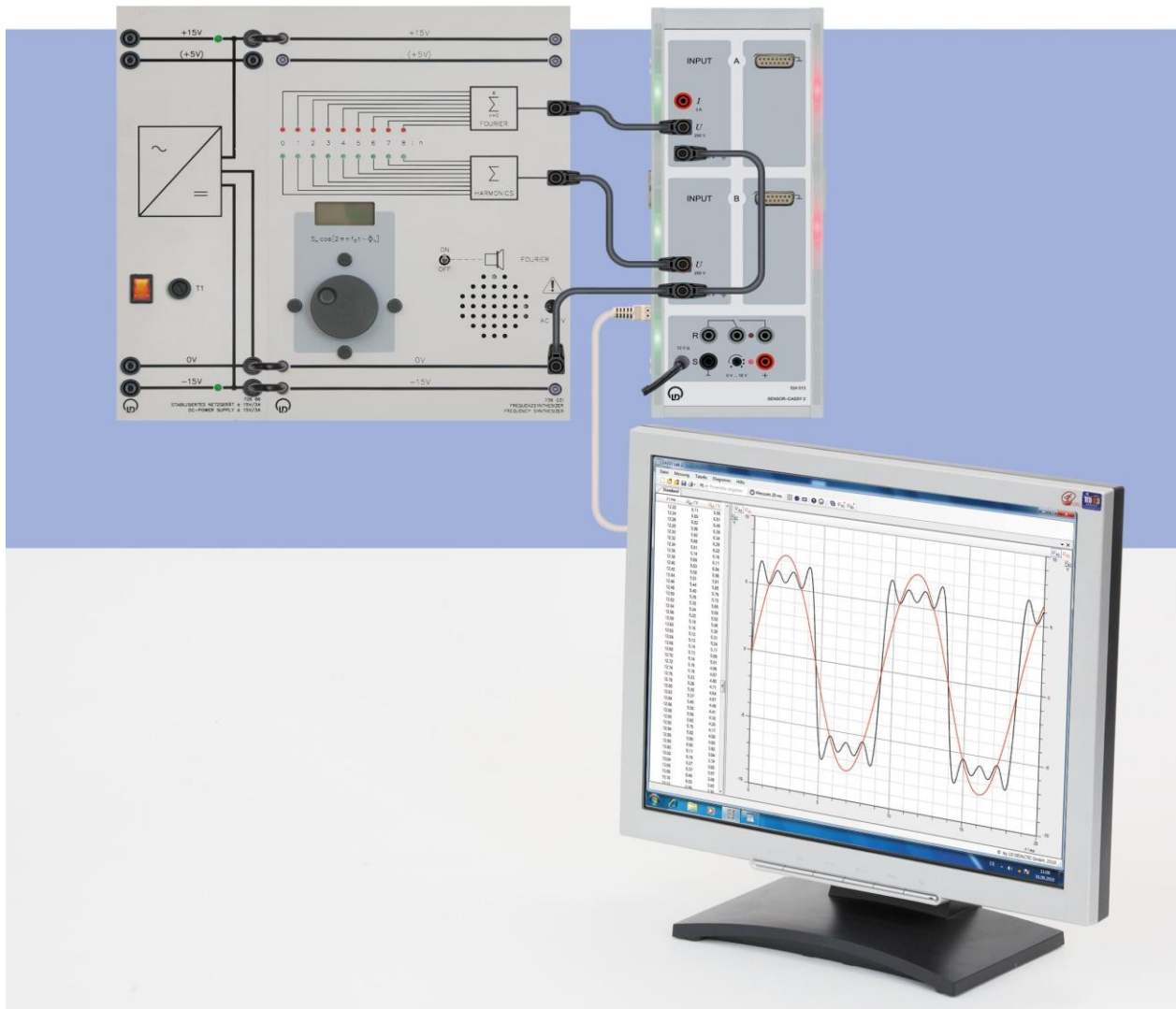

Experiment set-up for Fourier analysis and synthesis

Topics

- Symmetrical square wave
- Pulse train
- Triangle and saw tooth signals
- Modulations and beatings
- Rectified signals

T 7.2.1 Analog Transmission Technology

T 7.2.1.2 Fourier Analysis and Synthesis

The superposition of a number of harmonic oscillations, whose frequencies are integer multiples of a fundamental frequency f_0 gives a periodic but **non**-harmonic interference. This basic fact is of far-reaching importance for telecommunications. The phenomena is intensively explored experimentally using the frequency synthesizer. Here the student acquires a well-grounded knowledge in the area of signal display in the time- and spectral domain.

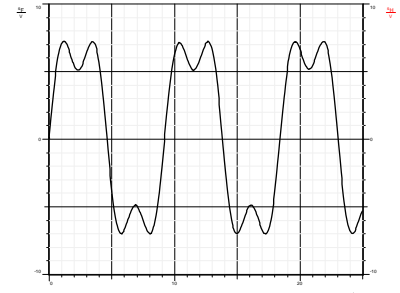

CASSY LAB 2

Superposition of the harmonics s_1 and s_3 of a square wave signal

EQUIPMENT LIST T 7.2.1.2

Fourier Analysis and Synthesis

Quantity	Cat.-no	Description
1	736 031	Frequency Synthesizer
1	524 013S	Sensor-CASSY 2 Starter
1	568 472	Book: Fourier-Analysis and Synthesis

A complete material list including accessories is available on request.

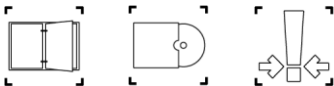

T 7.2.1 Analog Transmission Technology

T 7.2.1.3 Amplitude Modulation

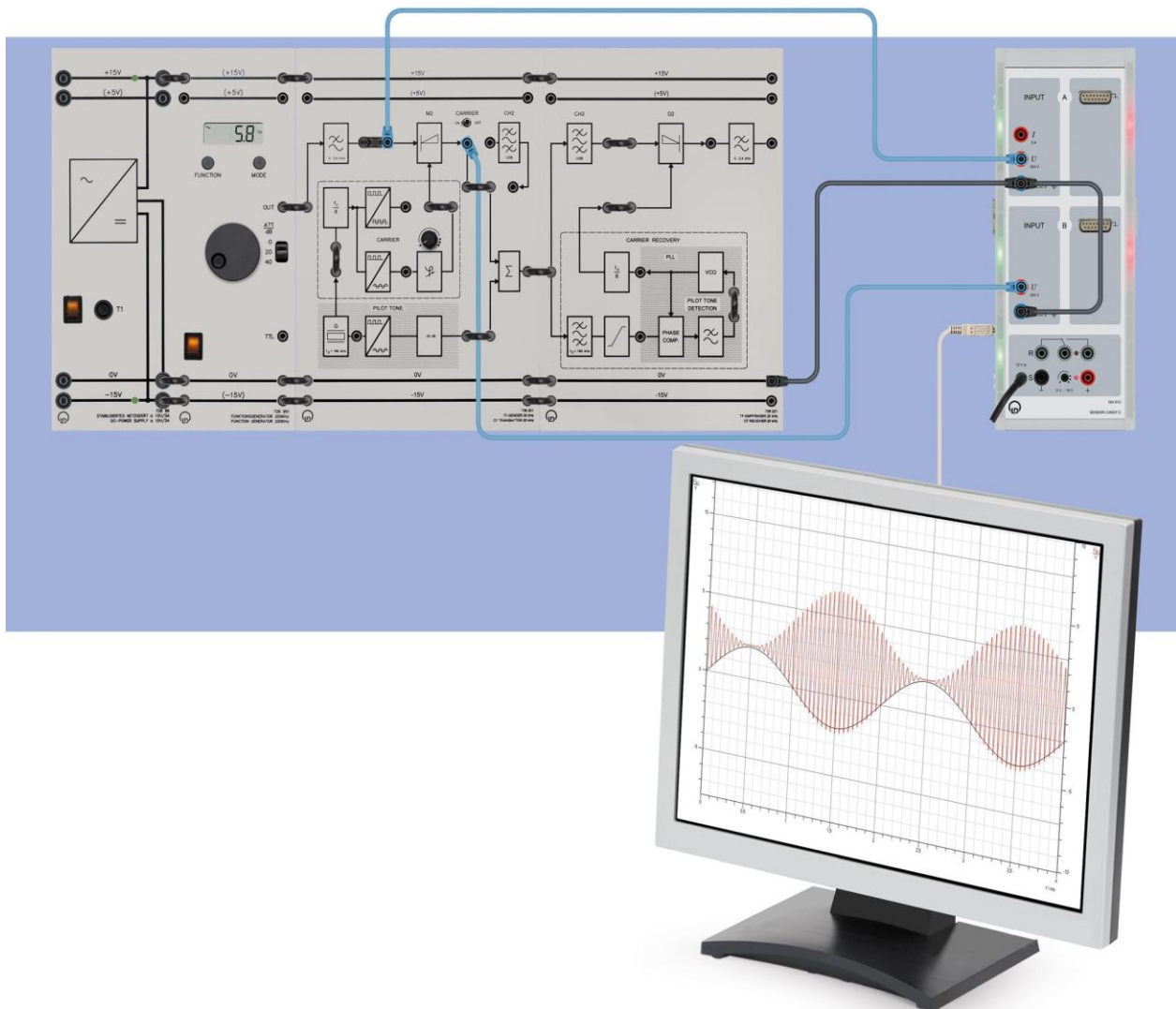

Experiment set-up for amplitude modulation

Topics (Selection)

- ➔ Modulation and beating
- ➔ Spectra
- ➔ Sidebands in normal and inverse position
- ➔ Bandwidth requirements for AM
- ➔ Amplitude deviation, degree of modulation, modulation trapezoid
- ➔ Residual carrier, carrier recovery
- ➔ Synchronous demodulation

T 7.2.1 Analog Transmission Technology

T 7.2.1.3 Amplitude Modulation

AM constitutes the classical form of modulation. Even today it is ubiquitous and is applied in television technology or in mobile radio networks for example. The equipment set is used to investigate the design of transmitters and receivers with their complex subassemblies. Measurements are taken of the dynamic characteristics and the spectra of the beatings and modulations.

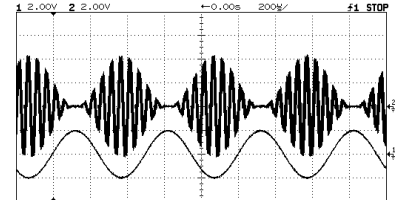

CASSY Lab 2

Measurement of AM with carrier.
Degree of modulation $m = 100\%$

AM constitutes the classical form of modulation. Even today it is ubiquitous and is applied in television technology or in mobile radio networks for example. The equipment set is used to investigate the design of transmitters and receivers with their complex subassemblies. Measurements are taken of the dynamic characteristics and the spectra of the beatings and modulations.

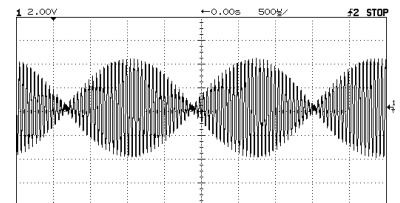

CASSY Lab 2

Measurement of AM without carrier.

Basic equipment set for the fundamental experiments of AM.

EQUIPMENT LIST T 7.2.1.3

Amplitude Modulation

Quantity	Cat.-no	Description
1	736 201	CF Transmitter 20 kHz
1	736 221	CF Receiver 20 kHz
1	524 013S	Sensor-CASSY 2 Starter
1	564 052	Book: Amplitude Modulation

A complete material list including accessories is available on request.

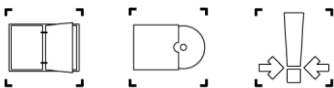

T 7.2.1 Analog Transmission Technology

T 7.2.1.4 Applied Amplitude Modulation

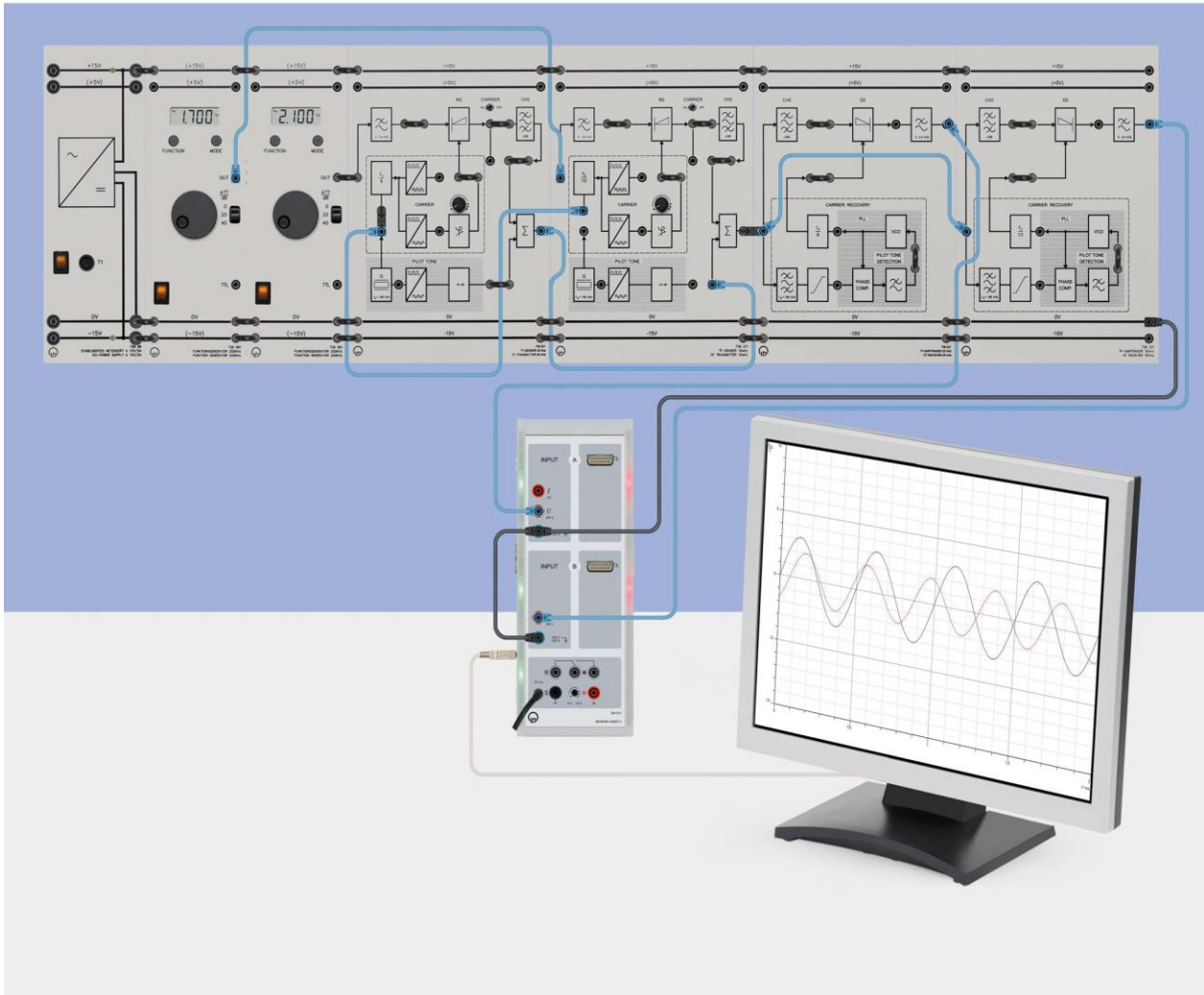

Experiment set-up for the two channel frequency division multiplex system (FDMA).

Topics (selection)

- ➔ Quadrature amplitude modulation
- ➔ Independent sidebands (ISB)
- ➔ Frequency multiplex systems (FDMA)
- ➔ Carrier recovery using PLL
- ➔ Determining channel cross talk

T 7.2.1 Analog Transmission Technology

T 7.2.1.4 Applied Amplitude Modulation

Amplitude modulation for advanced experiments. Here interesting applications are investigated like frequency multiplex technology, quadrature amplitude modulation QAM and the methods of independent sidebands (ISB).

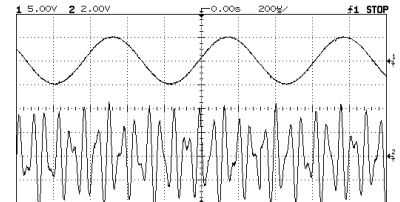

CASSY Lab 2
Measurement of QAM

Complete equipment set for the fundamental and advanced experiments of AM. This set includes the material from T 7.2.1.3.

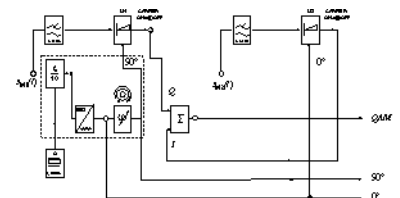

Setting up the QAM modulator with modulators for the quadrature- and inphase component.

EQUIPMENT LIST T 7.2.1.4

Applied Amplitude Modulation

Quantity	Cat.-no	Description
1	736 201	CF Transmitter 20 kHz
1	736 211	CF Transmitter 16 kHz
1	736 221	CF Receiver 20 kHz
1	736 2321	CF Receiver 16 kHz
1	524 013S	Sensor-CASSY 2 Starter
1	564 052	Book: Amplitude Modulation
1	564 062	Book: Applied Amplitude Modulation

A complete material list including accessories is available on request.

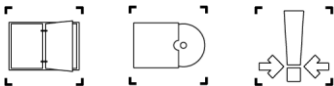

T 7.2.1 Analog Transmission Technology

T 7.2.1.5 Frequency Modulation

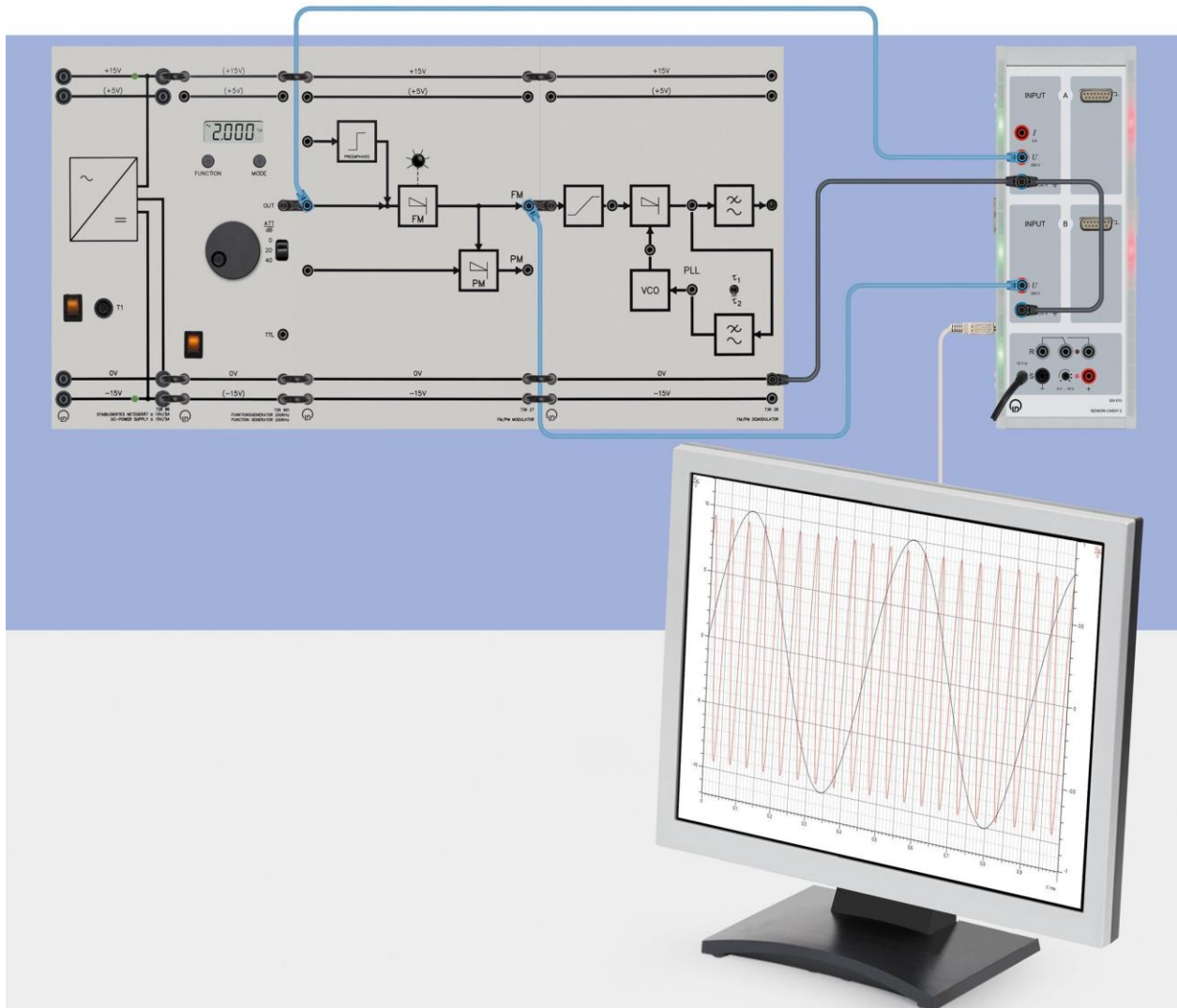

FM: Modulation, demodulation and the recording of spectra

Topics (selection)

- ➔ Dynamic response of FM and PM
- ➔ Determining the frequency deviation and modulation index
- ➔ Investigating of FM- and PM-spectra
- ➔ Bandwidth requirement of FM
- ➔ Principle of preemphasis
- ➔ Demodulation of FM and PM
- ➔ Recording the modulator characteristics

T 7.2.1 Analog Transmission Technology

T 7.2.1.5 Frequency Modulation (FM)

Frequency and phase modulation are forms of angle modulation. Frequency modulation happens to play a major role in commercial telecommunications (VHF radio). With this training systems the students learn about modulators as important non-linear systems.



FM is widely used for broadcasting radio programs.

The spectrum of FM is non-linear. It contains of an infinite number of sidelines.

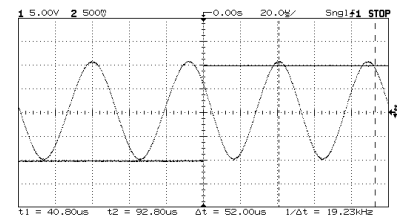
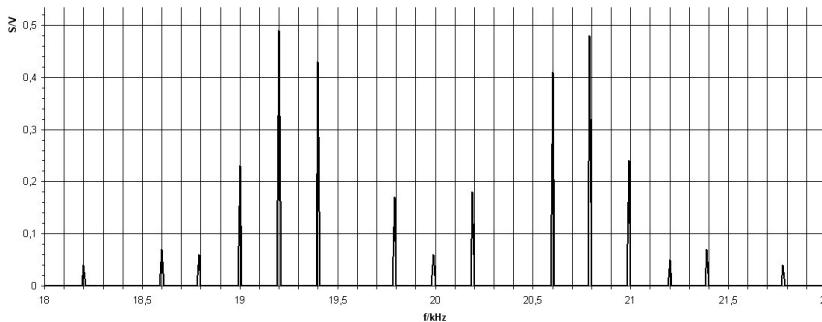

FM modulated by a square wave signal.

EQUIPMENT LIST T 7.2.1.5

Frequency Modulation

Quantity	Cat.-no	Description
1	736 27	FM/PM-Modulator
1	736 28	FM/PM-Demodulator
1	524 013S	Sensor-CASSY 2 Starter
1	564 072	Book: Frequency Modulation

A complete material list including accessories is available on request.

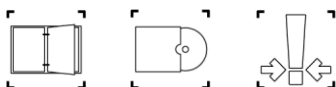

T 7.2.2 Digital Transmission Technology

T 7.2.2.1 Pulse Code Modulation (PCM)

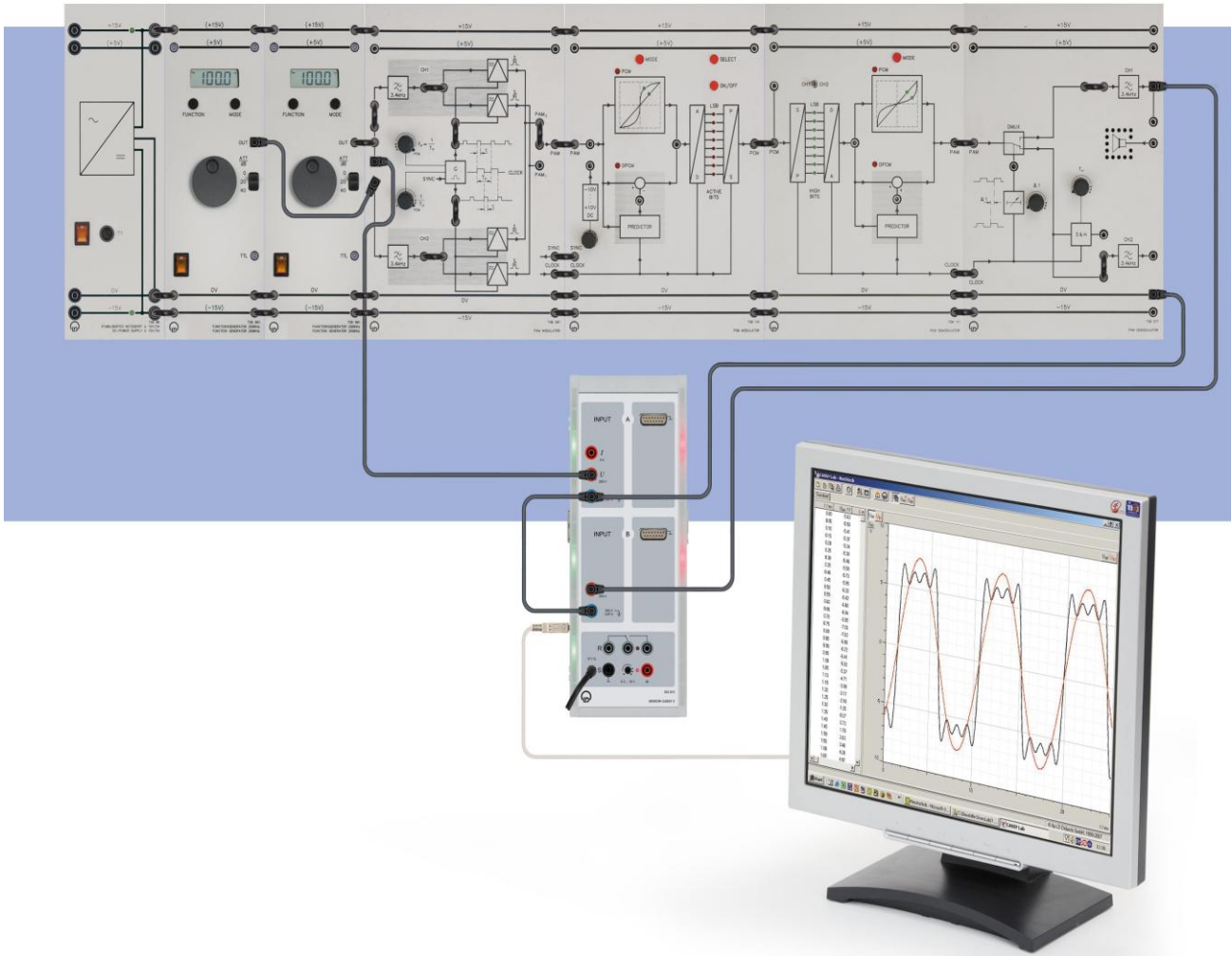

Experiment set-up for two channel time division multiplex system

Topics (selection)

- ➔ PAM-spectrum, sampling theorem
- ➔ Sub-sampling and aliasing
- ➔ Effects of aliasing, aliasing in the time domain
- ➔ Non linear distortions caused by sub sampling
- ➔ Recording of amplitude frequency responses
- ➔ Time division multiplexing
- ➔ Linear and non linear quantisation, companding, coding
- ➔ Quantisation noise, word- and frame synchronization
- ➔ Channel crosstalk
- ➔ DPCM

T 7.2.2 Digital Transmission Technology

T 7.2.2.1 Pulse Code Modulation (PCM)

Only four training panels are enough to enter into the fascinating world of digital transmission technology. In modern, micro-processor-controlled circuitry this training system makes it possible to conduct experiments and present all the important topics in the realm of PAM and PCM.

Features

- Two channels for experiments with time division multiplexing (TDMA).
- Asynchronous data transmission. Just like real commercial systems synchronization (frame, word and bit synchronization) is embedded in the data flow.
- Interference can be simulated by enabling and disabling single bits.

PCM is transmitted in the global long-distance networks via optical fibers and microwave links. Both transmission methods are also possible using the PCM training system.

The new documentation is available as E-Book.

EQUIPMENT LIST T 7.2.2.1

Pulse Code Modulation

Quantity	Cat.-no	Description
1	736 061	PAM-Modulator
1	736 071	PAM-Demodulator
1	736 101	PCM-Modulator
1	736 111	PCM-Demodulator
1	524 013S	Sensor-CASSY 2 Starter
1	564 002	Book: Pulse Code Modulation

A complete material list including accessories is available on request.

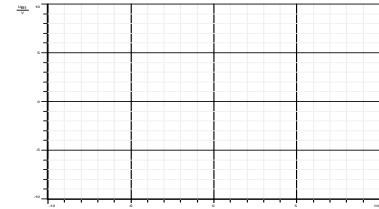
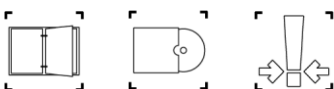

CASSY Lab 2
Compander characteristic

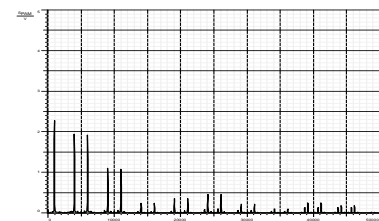
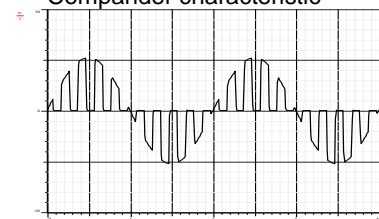

CASSY Lab 2
PAM spectra

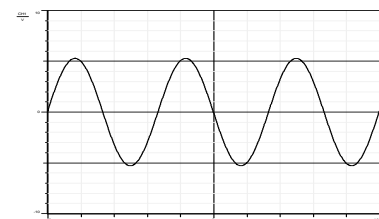

CASSY Lab 2
Time division multiplex signals

T 7.2.2 Digital Transmission Technology

T 7.2.2.2 Pulse Time Modulation (PTM)

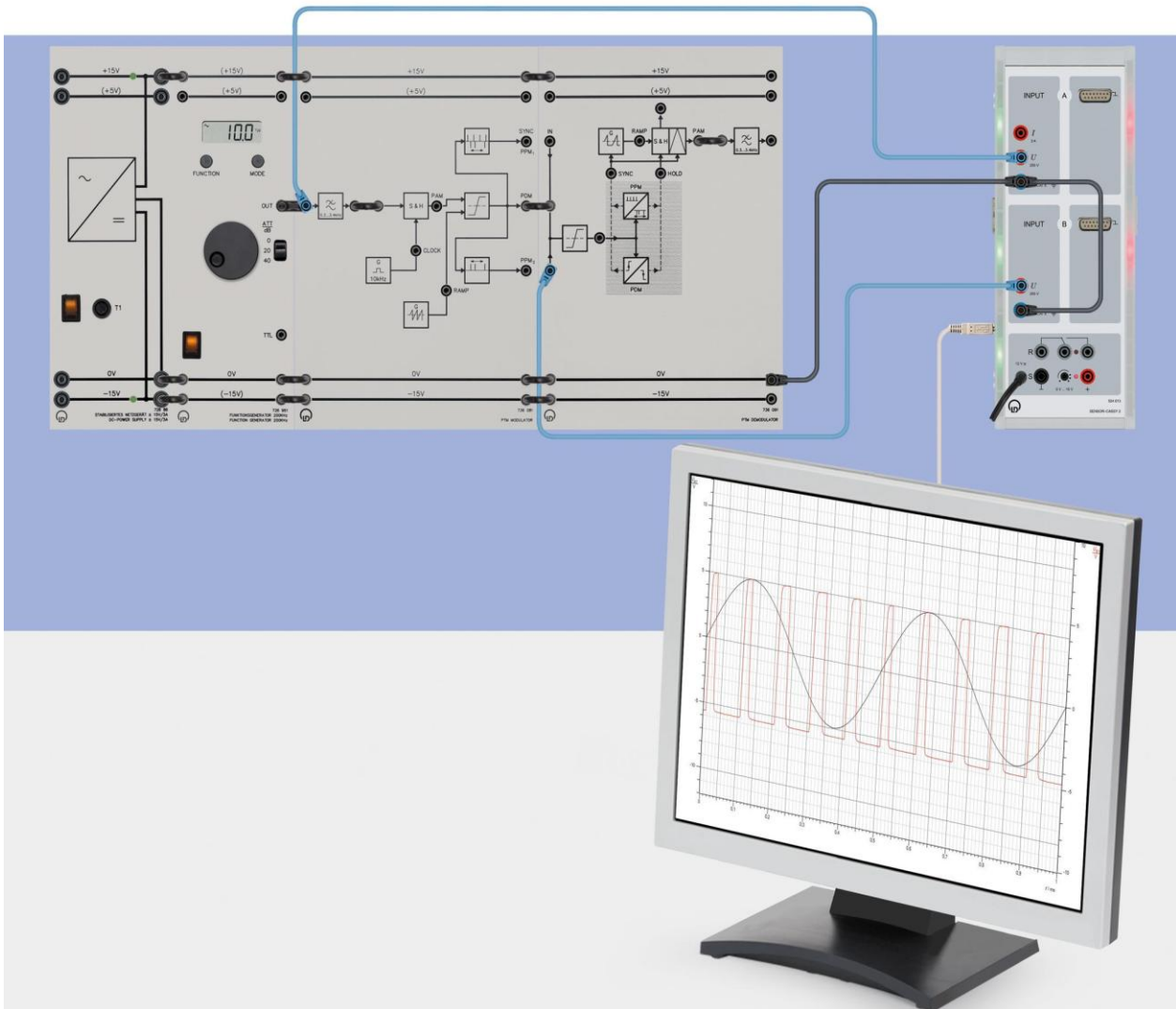

Experiment set-up for PDM and PPM in time domain and frequency domain

Topics (selection)

- ➔ Pulse spectra, function of the S&H element
- ➔ Sidebands in normal and inverse position
- ➔ Sampling theorem
- ➔ Saw tooth method
- ➔ Demodulation by low pass filtering and S&H element
- ➔ Synchronization of the PTM demodulator
- ➔ Quasiternary signals in RZ format
- ➔ Modulator characteristics

T 7.2.2 Digital Transmission Technology

T 7.2.2.2 Pulse Time Modulation (PTM)

Pulse duration modulation PDM and pulse-phase modulation PPM are jointly referred to as pulse time modulation methods. PPM exhibits a much lower susceptibility to noise. For that reason it is used for signal transmission in time-division multiplex systems, e.g. when fiber optic transmission systems are used.

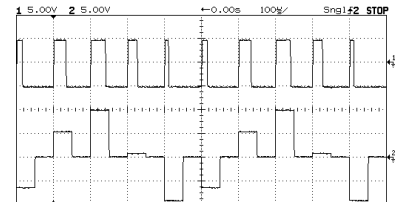

CASSY Lab 2
Signals for PDM and PPM

PDM plays no role in the transmission of signals. An interesting application area for this technology is found in switching amplifiers in AM transmitters and in power electronics.

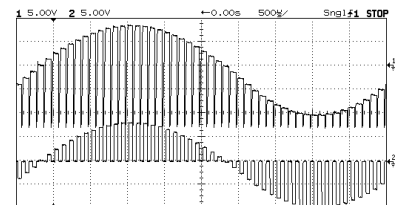

CASSY Lab 2
Saw tooth and PAM signal

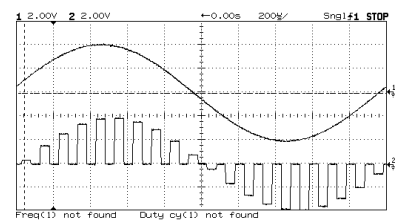

CASSY Lab 2
PTM demodulation via PAM

EQUIPMENT LIST T 7.2.2.2

Pulse Time Modulation

Quantity	Cat.-no	Description
1	736 081	PTM Modulator
1	736 091	PTM Demodulator
1	524 013S	Sensor-CASSY 2 Starter
1	564 012	Book: Pulse Time Modulation

A complete material list including accessories is available on request.

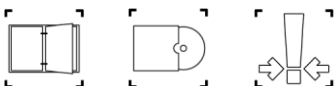

T 7.2.2 Digital Transmission Technology

T 7.2.2.3 Delta Modulation (DM)

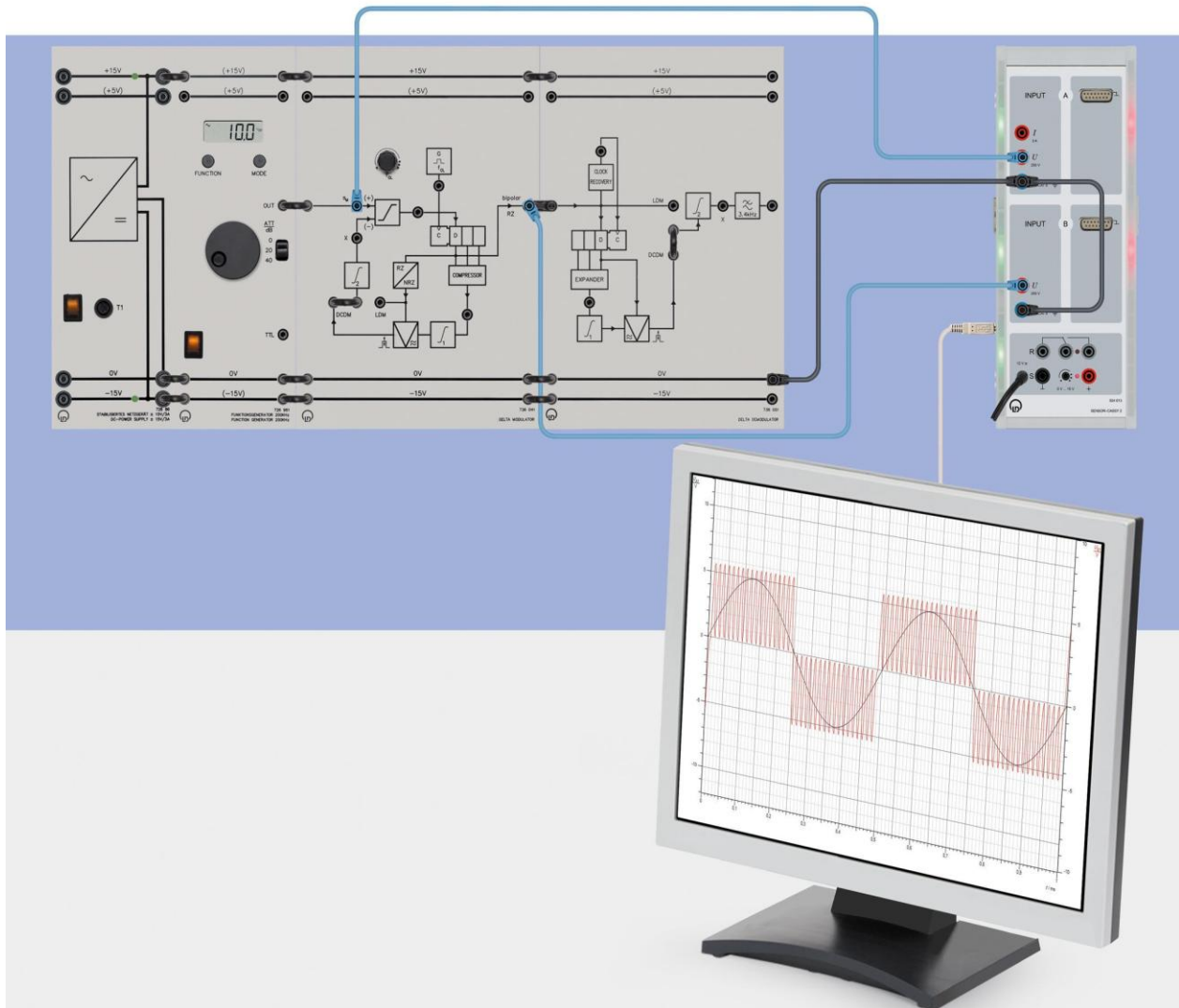

Experiment set-up for delta modulation

Topics (selection)

- ➔ Interference susceptibility of DM
- ➔ Granular noise
- ➔ Slope overload
- ➔ Dynamics for LDM and DCDM
- ➔ Linear and adaptive DM
- ➔ Clock recovery, synchronization
- ➔ Demodulation with double integrator

T 7.2.2 Digital Transmission Technology

T 7.2.2.3 Delta Modulation (DM)

Delta modulation is fascinating because of its simple circuitry and huge variety. Out of the many possible methods we have selected the linear delta modulation (LDM) and the adaptive method of DCDM (Digital Controlled Delta Modulation) to be implemented in this system.

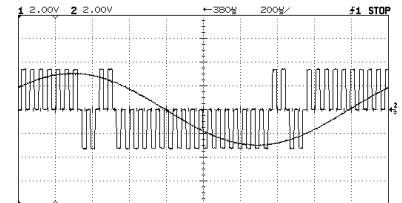

CASSY Lab 2
DM signals in the time domain

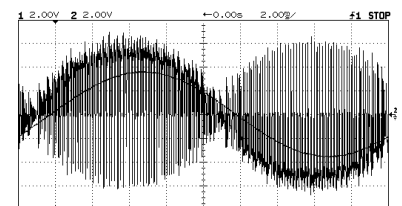

CASSY Lab 2
DCDM is a method for adaptive delta modulation

Typical errors like slope overload and granular noise are investigated. The comparison of the two DM methods gives interesting results. The output signals are generated in RZ and NRZ Format.

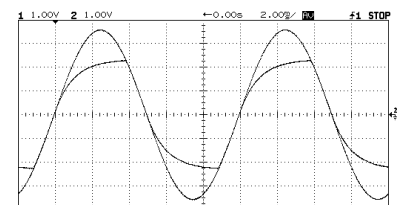

CASSY Lab 2
Slope overload

EQUIPMENT LIST T 7.2.2.3

Delta Modulation

Quantity	Cat.-no	Description
1	736 041	Delta Modulator
1	736 051	Delta Demodulator
1	524 013S	Sensor-CASSY 2 Starter
1	564 02	Book: Delta Modulation

A complete material list including accessories is available on request.

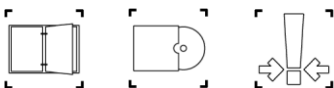

T 7.2.2 Digital Transmission Technology

T 7.2.2.4 Shift Keying and Modems

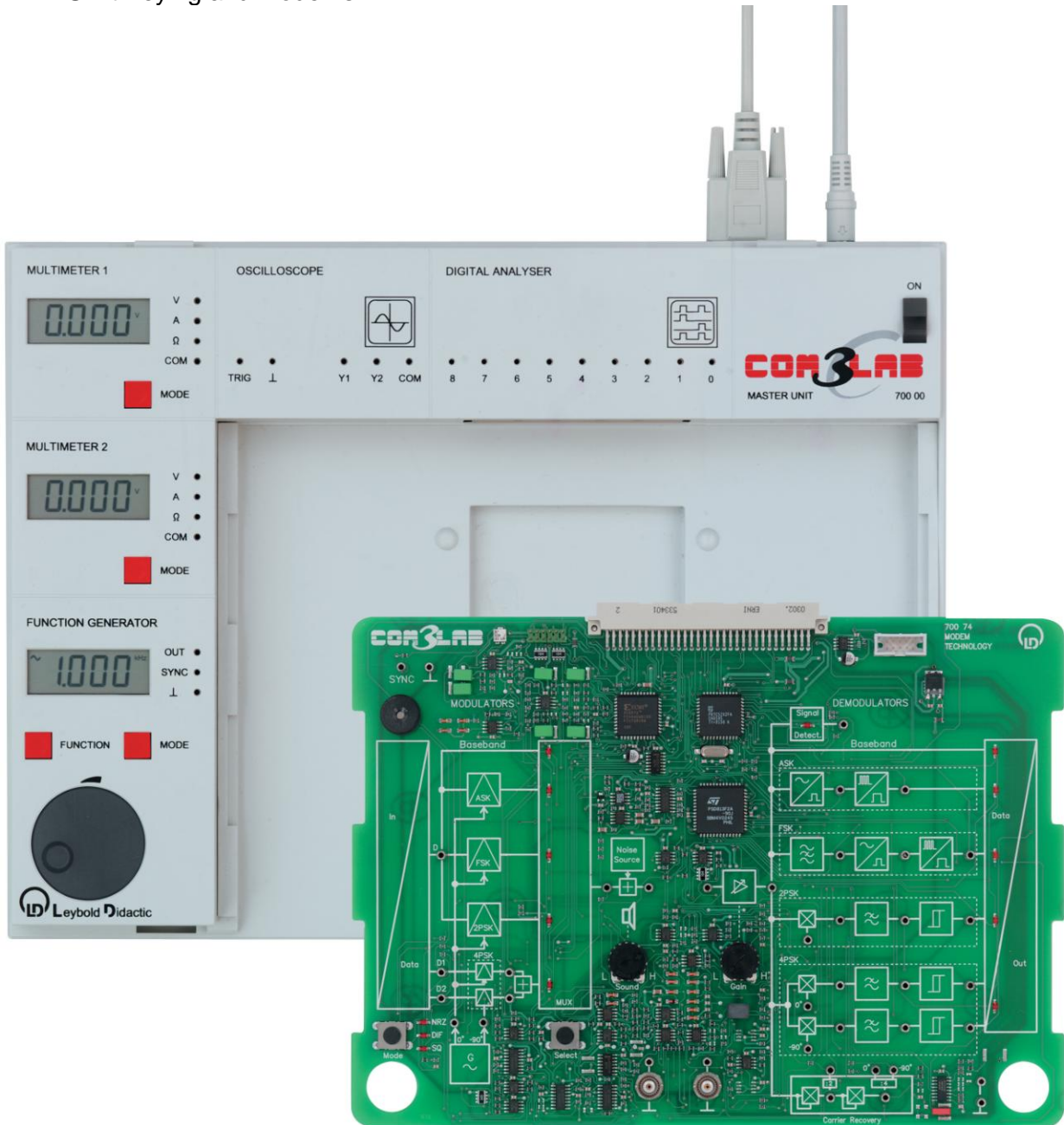

Master Unit with COM3LAB-course Modem Technology.

Topics (selection)

- ➔ ASK, FSK, 2PSK, 4PSK
- ➔ Time behavior and spectra of shift-keyed signals
- ➔ NRZ, difference phase coding
- ➔ Simplex and duplex mode of operation
- ➔ Fault simulation, signal noise ratio SNR
- ➔ Error detection, Error correction

T 7.2.2 Digital Transmission Technology

T 7.2.2.4 Shift Keying and Modems

Data transmission via telephone networks, make use of shift keyed signals as modulation techniques. The COM3LAB based training system deals with all classic variants of shift keying including the QPSK and those types used in mobile communications like MSK and GMSK.



The Morse key: The classic predecessor for shift keying.

Of special interest are the new experiments comparing the different types of modulated signals with respect to their noise sensitivity. To run this experiment a build in noise generator deliberately disturbs the data (text) signals on the transmission channel. The integrated Bit Error Rate Counter measures the resultant errors with reference to noise power and type of shift keying.

Interesting is the duplex mode of operation between two courses Modem Technology via external cables. Included into this COM3LAB course are all necessary measurement instruments like oscilloscope and spectrum analyzer.

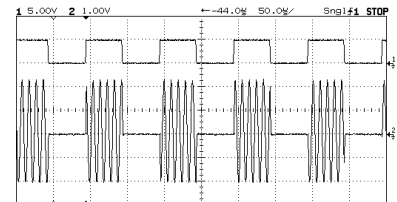

CASSY Lab 2

ASK signal in time representation

EQUIPMENT LIST T 7.2.2.4

Shift Keying and Modems

Quantity	Cat.-no	Description
1	700 00	Master Unit
1	700 74	COM3LAB-Kurs: Modem Technology
1	736 461	Set of Coaxial Lines
1	736 481	Star Quad Cable

A complete material list including accessories is available on request.



T 7.2.2 Digital Transmission Technology

T 7.2.2.5 COM3LAB-Multimedia: Transmission Technology



A selection of COM3LAB-courses tailored to the requirements of training in telecommunication.

Topics (selection)

- Modulation by shift keying
- PAM / PCM
- 2-wire, 4-wire, coaxial lines
- Fundamentals of fiber optics
- Fault simulation, error detection, error correction

T 7.2.2 Digital Transmission Technology

T 7.2.2.5 COM3LAB-Multimedia: Transmission Technology

This equipment package includes **all** COM3LAB courses dealing with topics of digital modulations and telecommunication lines.



Digital communication

The multimedia courses of this package give a deep insight into the world of modern IT technology. Emphasis is laid on experiments with the integrated lab instruments such as function generator, oscilloscope and spectrum analyzer.



Fiber optics

For completing the subject the multimedia package *T 7.3 Transmitting and Receiving Technology* is recommended.



Coaxial lines

EQUIPMENT LIST T 7.2.2.5

COM3LAB-Multimedia: Transmission Technology

Quantity	Cat.-no	Description
1	700 00	Master Unit
1	700 73	COM3LAB Course: Digital Communication Technol.
1	700 74	COM3LAB Course: Modem Technology
1	700 75	COM3LAB Course: Telecommunication Lines

A complete material list including accessories is available on request.

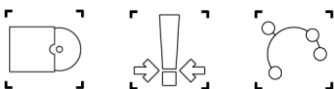

T 7.2.3 Noise

Modulation affected by Noise

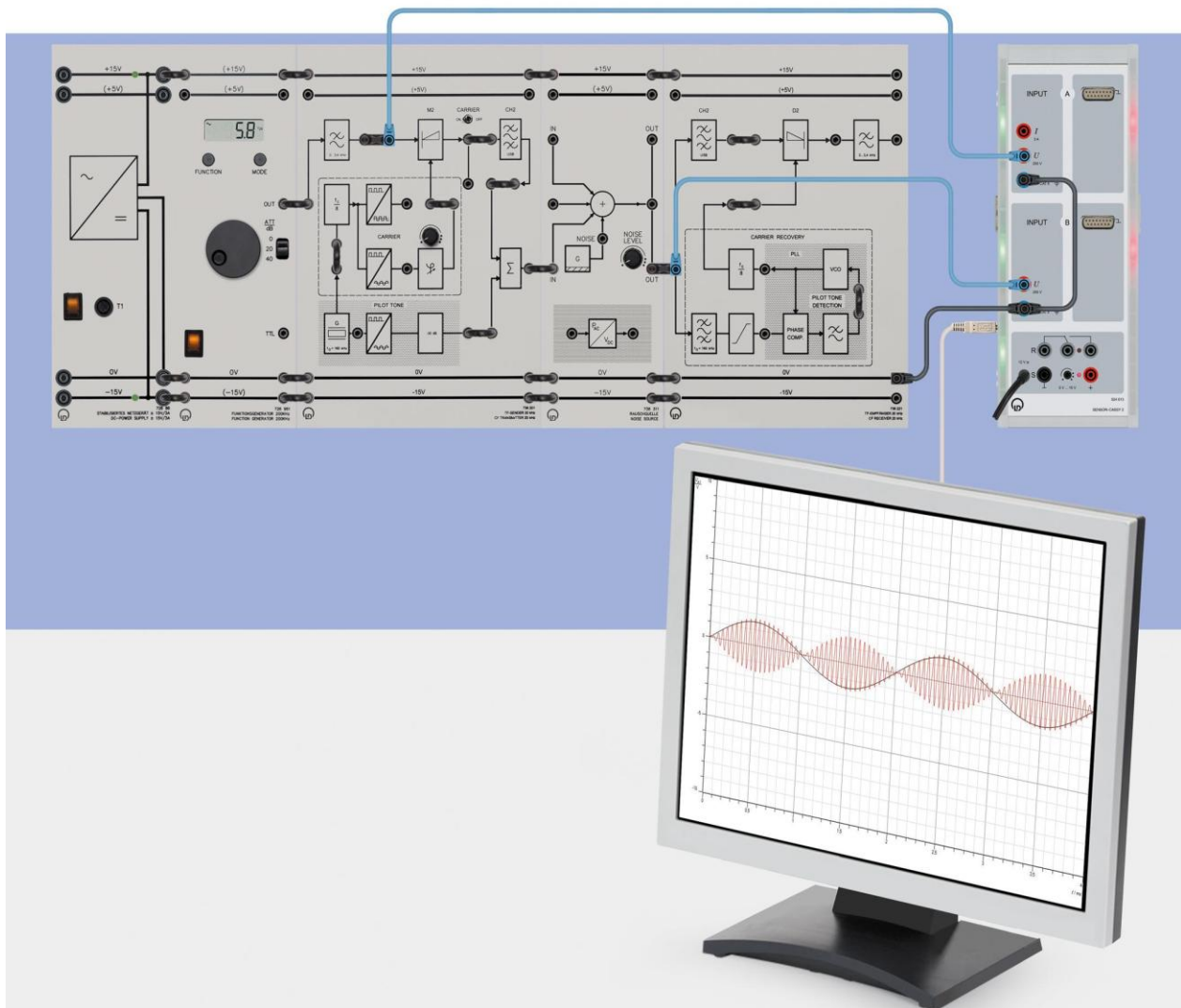

Typical experiment set-up for investigations on noise behavior of different modulation methods

Topics (selection)

- ➔ Artificial channel modeling
- ➔ Noise source with adjustable power
- ➔ Determining the signal noise ratio
- ➔ Measurements on AM, FM, PAM etc.

T 7.2.3 Noise

Modulation affected by Noise

Wanted signals are superimposed by interference and noise on the transmission channel. An essential operation of modulation is to keep the interference affecting the wanted signal as small as possible.

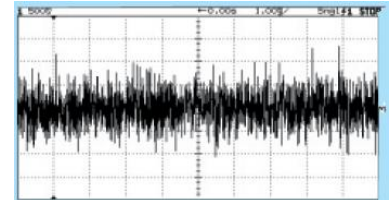

CASSY Lab 2
Measurement of noise

The kind of interference arising in real, analog and digital transmission links is simulated by connecting a noise source and investigated using measurement techniques. Furthermore the individual transmission methods are comparatively evaluated with respect to noise sensitivity.

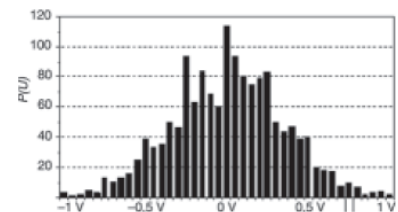

Noise statistics

This kit needs at least one of the following modulation methods:

- T 7.2.1.3 Amplitude Modulation
- T 7.2.1.5 Frequency Modulation
- T 7.2.2.1 Pulse Code Modulation
- T 7.2.2.2. Pulse Time Modulation

EQUIPMENT LIST T 7.2.3

Noise

Quantity	Cat.-no	Description
1	736 27	FM/PM Modulator
1	736 28	FM/PM Demodulator
1	736 061	PAM Modulator
1	736 071	PAM Demodulator
1	736 081	PTM Modulator
1	736 091	PTM Demodulator
1	736 101	PCM Modulator
1	736 111	PCM Demodulator
1	736 201	CF Transmitter 20 kHz
1	736 221	CF Receiver 20 kHz
1	736 311	Noise Source
1	524 013S	Sensor-CASSY 2 Starter
1	564 181	Book: Noise on Transmission Channels

A complete material list including accessories is available on request.

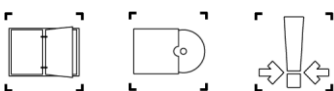

T 7.2.4 Transmission Lines

T 7.2.4.2 Measurements on Four-Wire Lines

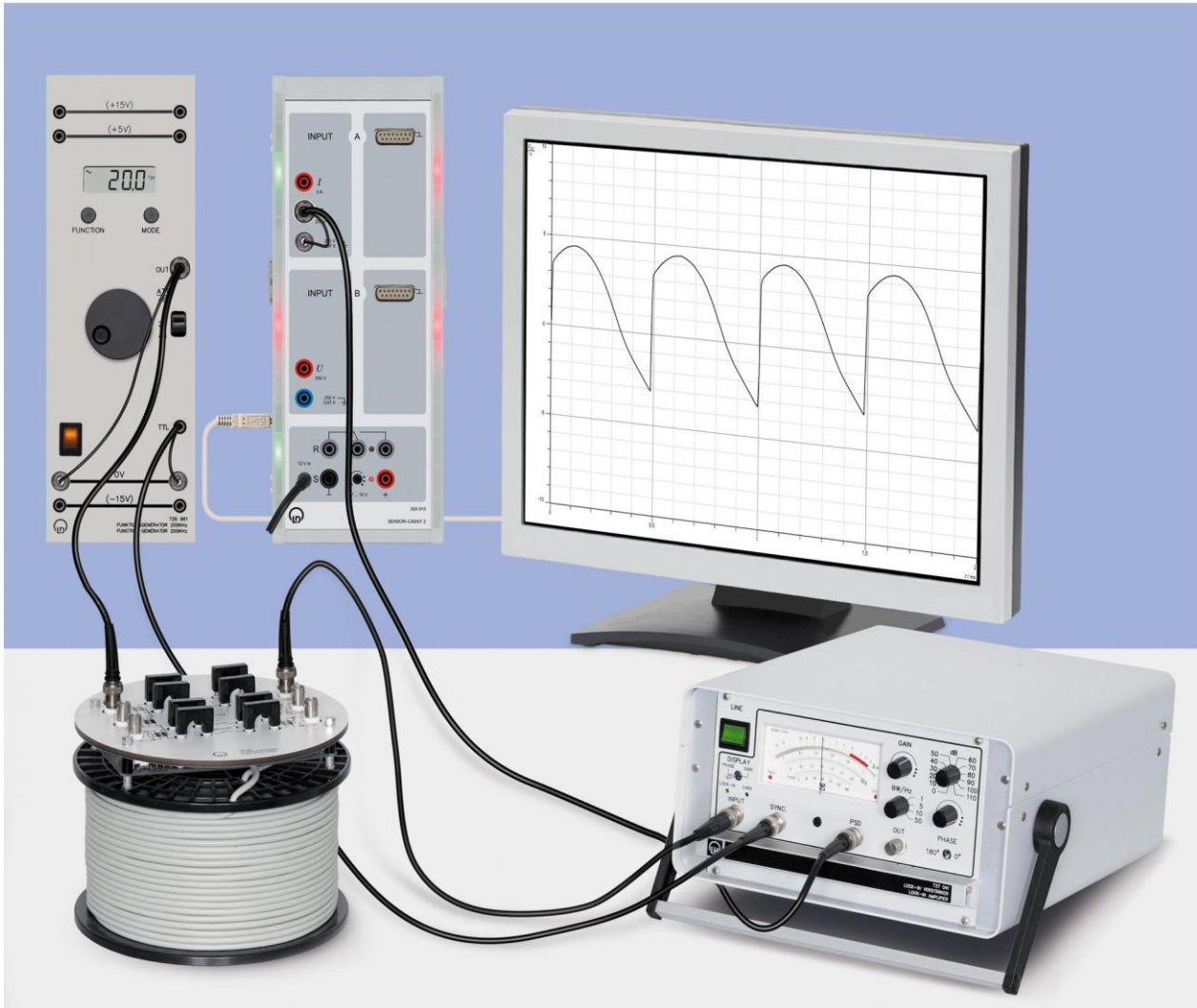

The star-quad investigated here consists of a commercial 4-wire transmission line. These kinds of lines are designed for minimum crosstalk. In order to be able to measure crosstalk at all, complex lock-in measurement technology is employed.

Topics (selection)

- ➔ Near and far-end crosstalk
- ➔ Phantom circuits
- ➔ Introducing Lock-In measurements techniques

T 7.2.4 Transmission Lines

T 7.2.4.2 Measurements on Four-Wire Lines

There is a huge number of different line types used in line-bound telecommunications. By exploiting various physical properties these transmission lines effectively transmit information across spatial distances. In the LD training system all of the important classes of transmission lines have been integrated:

- Multi-wired lines for classical IT-application
- Waveguides in microwave technology
- Dielectric lines in fiber optics

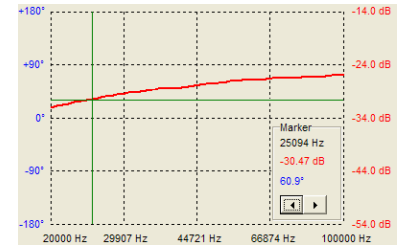

Crosstalk at a star quad cable

The problems involved in crosstalk and the phantom circuit are investigated on a real four-wire transmission line. Four-wire transmission lines of this type are used in service connections for long-distance telephone subscribers.

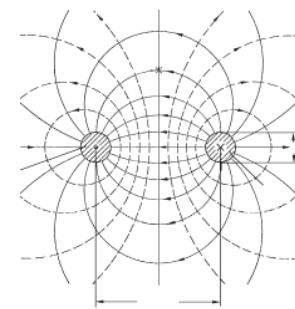

Field distribution in the two-wire line

EQUIPMENT LIST T 7.2.4.2

Measurements on Four-wire Lines

Quantity	Cat.-no	Description
1	737 481	Star Quad Cable
1	736 041	Lock-In Amplifier
1	524 013S	Sensor-CASSY 2 Starter
1	568 542	Book: Measurements on Four-Wire Lines

A complete material list including accessories is available on request.

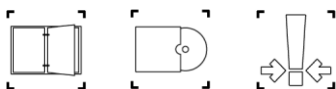

T 7.2.4 Transmission Lines

T 7.2.4.3 Measurements on Coaxial Lines

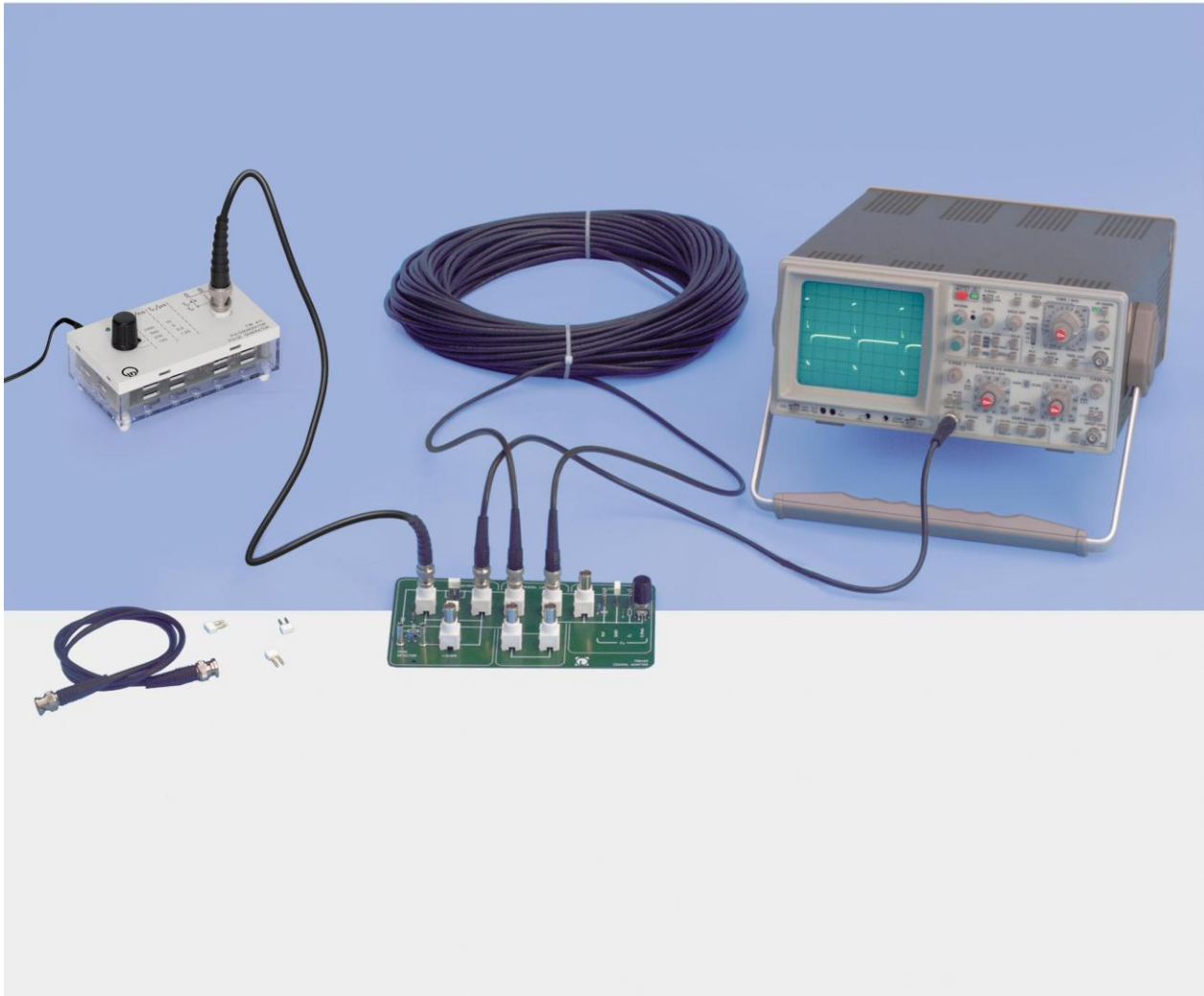

Reflexions on the coaxial line

Topics (selection)

- Impulse behavior of coaxial lines
- Terminations without reflexions
- Generation of multiple echoes
- Power transmission on cables

T 7.2.4 Transmission Lines

T 7.2.4.3 Measurements on Coaxial Lines

Coaxial lines are used internationally in cable television networks, telephone technology, studio engineering and in the laboratory. In technical instruction they are particularly well suited for the investigation of faulty line matching, reflections, attenuations etc. The LD training system investigates two coaxial lines with different parameters and thus permits the students to make comparative assessments. The total line length is 200 m.

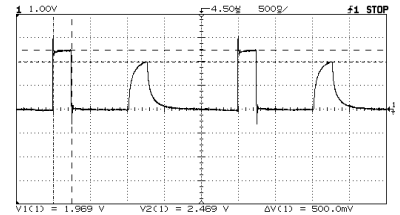

Mismatch on a coaxial line

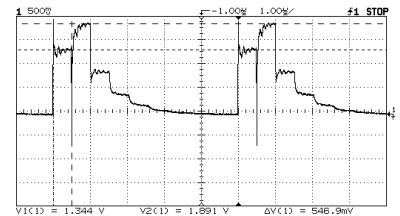

Multiple echoes

EQUIPMENT LIST T 7.2.4.3

Measurements on Coaxial Lines

Quantity	Cat.-no	Description
1	737 461	Set of Coaxial Lines
1	736 463	Coaxial Adapter
1	736 471	Pulse Generator
1	568 532	Book: Measurements on Coaxial Lines

A complete material list including accessories is available on request.

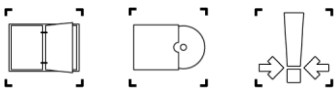

T 7.2.4 Transmission Lines

T 7.2.4.4 COM3LAB-Multimedia: Transmission Lines

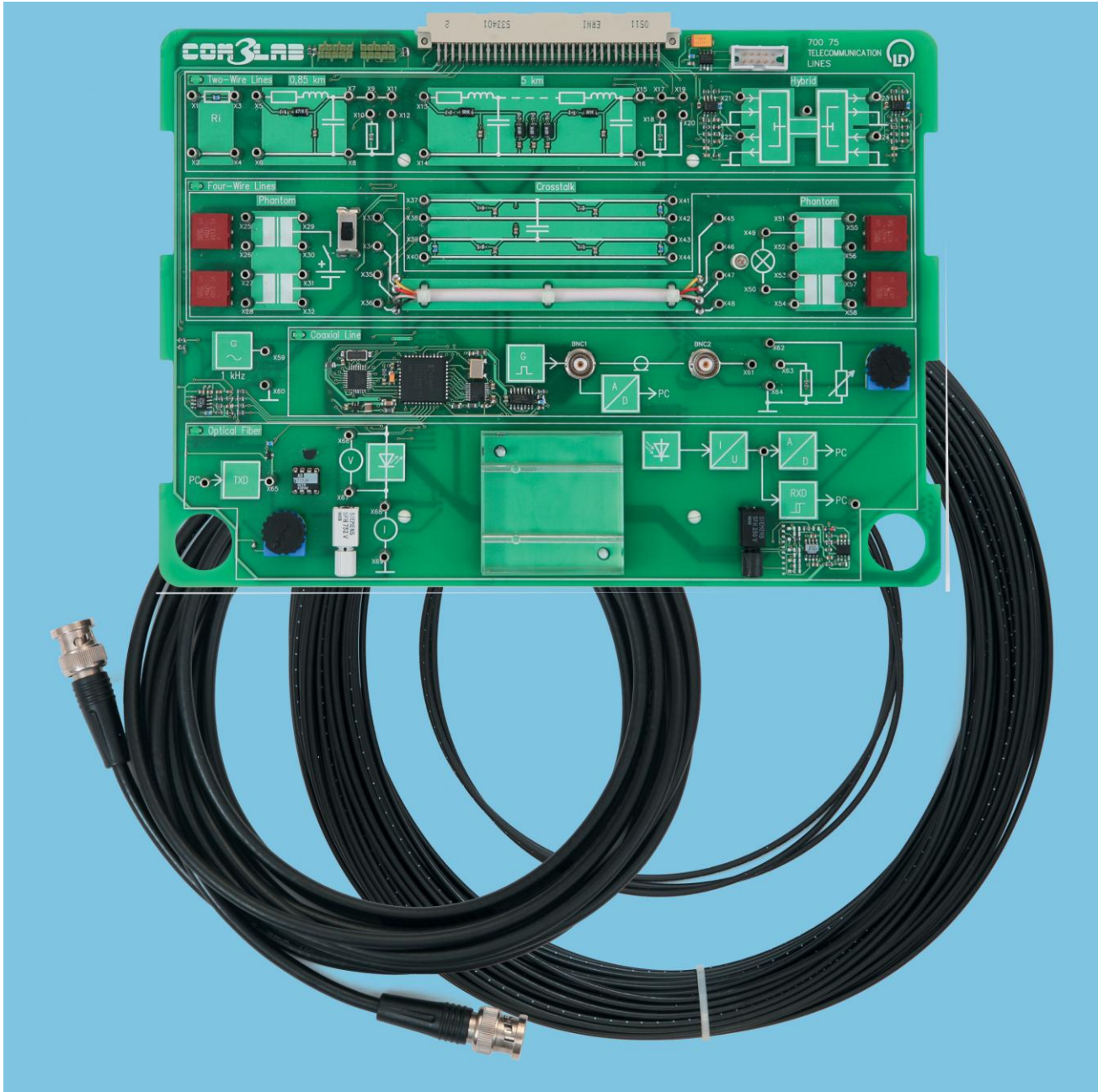

Master Unit with COM3LAB Course: Telecommunication Lines

Topics (selection)

- ➔ Two-wire / Four-wire lines
- ➔ Coaxial lines
- ➔ Fiber optics

T 7.2.4 Transmission Lines

T 7.2.4.4 COM3LAB-Multimedia: Transmission Lines

The subject transmission lines is represented in detail. There are experiments for the classical lines:

- Two-wire lines
- Four-wire lines
- Coaxial lines

Additionally there is an introduction into fiber optic systems. Apart from optical fibers in different lengths, the course contains a coaxial line (RG 58, $l = 50$ m).



Long distance lines in classic copper technology

The scope of measurement instruments includes a Bode plotter for the recording of frequency responses of 2-wire and 4-wire lines and an optical power meter. Evaluation by means of automatic routines accelerate the experimentation and facilitate the lab work.



Fiber optic telecommunication

EQUIPMENT LIST T 7.2.4.4

COM3LAB-Multimedia: Transmission Lines

Quantity	Cat.-no	Description
1	700 00	Master Unit
1	700 75	COM3LAB course: Telecommunication Lines

A complete material list including accessories is available on request.

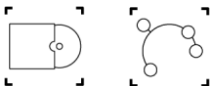

T 7.2.6 Fiber Optics

T 7.2.6.1 Experiments with PMMA-Fibers

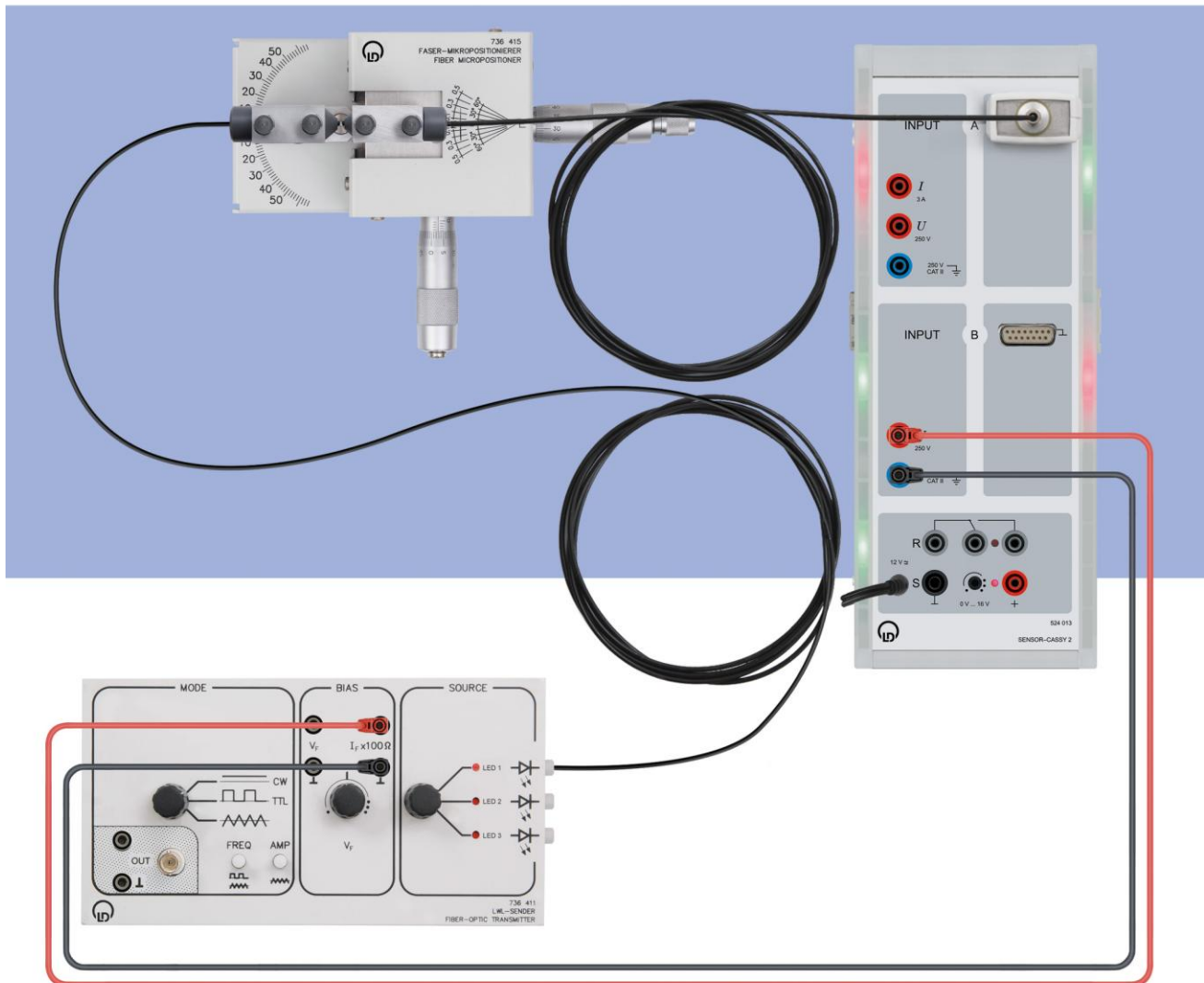

Signal transmission with fiber optics.

Topics

- ➔ Characteristics of LED, transimpedance amplifier
- ➔ Optical power of the transmitter LED
- ➔ Light guidance by fibers, numerical aperture
- ➔ Signal transmission with fiber
- ➔ Attenuation, fiber coupler, coupling losses
- ➔ Preparation of fiber ends
- ➔ Reduction of reflexion losses
- ➔ Undesired modes

T 7.2.6 Fiber Optics

T 7.2.6.1 Experiments with PMMA Fibers

Modern, line-bound telecommunications is increasingly using dielectric lines as the transmission medium of choice. Lines called optical fibers or waveguides have an enormous transmission capacity which is well-suited for the rapidly growing needs of world-wide communications. Apart from their use in communications engineering, optical fibers are also being used as sensors and in instrumentation technology. In contrast to conventional lines, optical fibers have a whole series of specific advantages including wire-tap security or safety in explosion-hazardous environments.

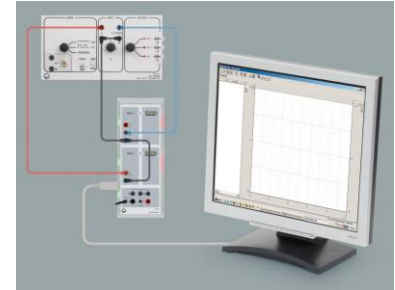

CASSY Lab 2
Plotting the LED characteristics

This small system permits a well-rounded and complete demonstration of the subject. It includes investigations on the principles of light propagation in multimode optical fibers, the design of optic couplers, the properties of fiber optic transmitter and receiver elements. One particularly clever aspect of the system involves the exercises on preparing the fiber butt joints, and reflexion reduction through polishing. The plastic optical fibers (PMMA) used are robust and thus ideal for student experiments. Quantitative optical power measurements are carried out with the Optical Power Sensor S, cat. no. 524 512,

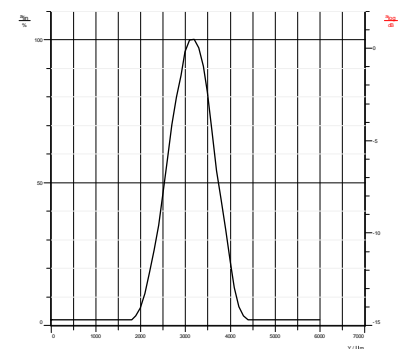

CASSY Lab 2
Losses for transversal offset

The documentation is available as E-Book.

EQUIPMENT LIST T 7.2.6.1

Experiments with PMMA Fibers

Quantity	Cat.-no	Description
1	737 411	Fiber-optic Transmitter
1	736 412	Fiber-optic Receiver
1	736 415	Fiber-Micropositioner
1	736 416	Mode Scrambler
1	736 421	Set of Fiber-optic Waveguides and Accessories
1	736 429	Fiber-optic Microscope
1	524 013S	Sensor-CASSY 2 Starter
1	524 0512	Optical Power Sensor S
1	564 481	Book: Experiments with PMMA Fibers

A complete material list including accessories is available on request.

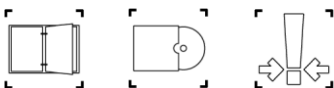

T 7.2.6 Fiber Optics

T 7.2.6.2 Data Transmission with Optical Fibers

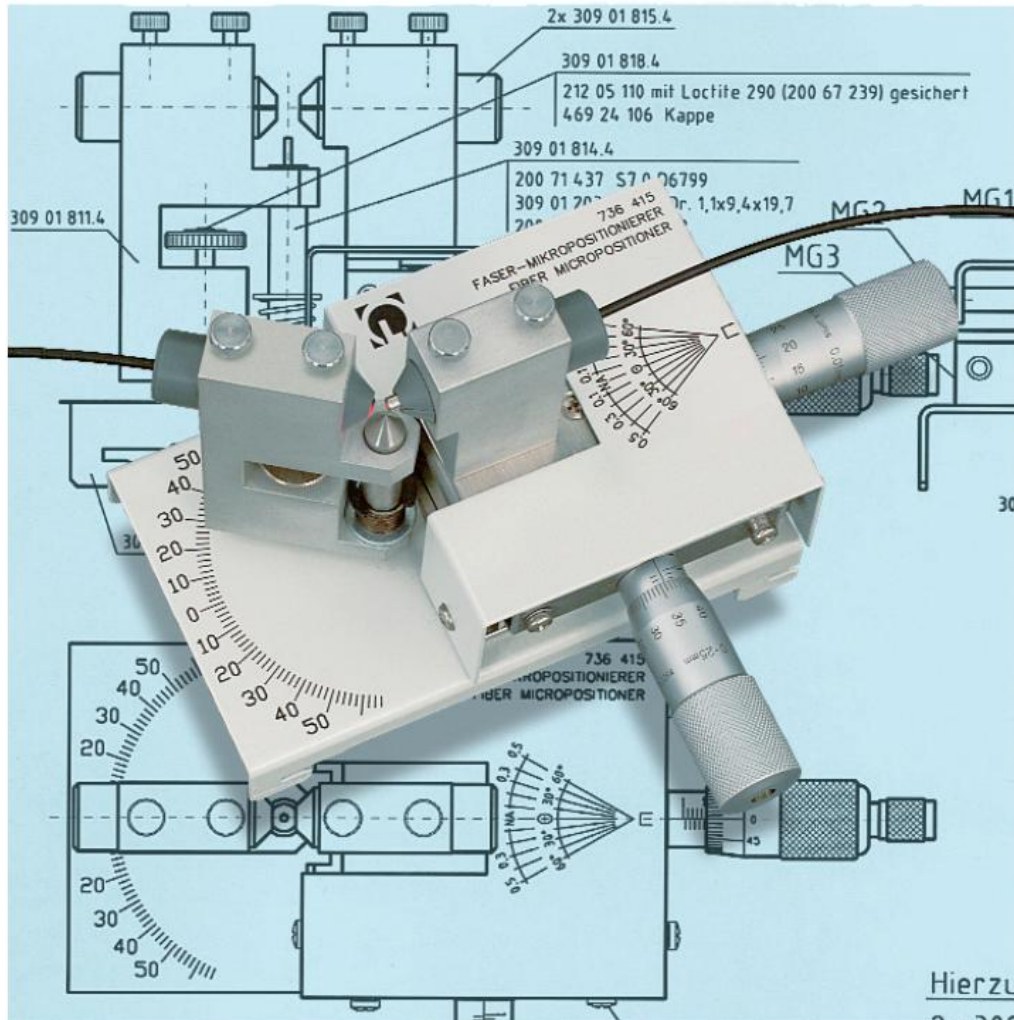

Topics

- Attenuation in and HCS-fibers
- PCM data transmission
- Determining the numerical aperture
- Reduction of reflexion losses at connectors
- Signal transmission with optical fibers
- Coupling losses

T 7.2.6 Fiber Optics

T 7.2.6.2 Data Transmission with Optical Fibers

Today fiber-optic waveguides are primarily to be found in communications networks. For this reason PCM coded signals are transmitted via optical fibers. The connection of the optical fibers to the optical transmitters/receivers is performed using the popular FSMA connector system. As optic fibers PMMA and glass fibers (HCS) are used.



Fibers for optical cables



LED as light source

EQUIPMENT LIST T 7.2.6.2

Data Transmission with Optical Fibers

Quantity	Cat.-no	Description
1	736 061	PAM Modulator
1	736 071	PAM Demodulator
1	736 101	PCM Modulator
1	736 111	PCM Demodulator
1	736 401	Fiber Optic Adapter
1	736 415	Fiber Micropositioner
1	736 416	Mode Scrambler
1	736 425	Set of FSMA Optical Fibers
1	736 429	Fiber-optic Microscope
1	524 013S	Sensor-CASSY 2 Starter
1	524 0512	Optical Power Sensor S
1	564 002	Book: Pulse Code Modulation
1	564 492	Book: Data Transmission with Optical Fibers

A complete material list including accessories is available on request.

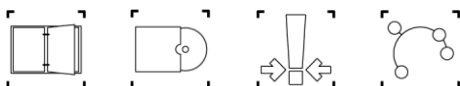

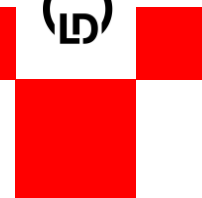

T 7.3 Transmitting and Receiving Technology



T 7.3 COM3LAB-Multimedia: Transmitting and Receiving Technology



Master Unit with COM3LAB courses: Transmitter- and Receiver Technology.

Topics (selection)

- Analog modulations, spectrum analysis
- Antennas, SWR measurements
- Data safety, cryptography
- PLL, synchronous- and envelope demodulation
- Telematics, telemetry

T 7.3 COM3LAB-Multimedia: Transmitting and Receiving Technology

The subject transmitter and receiver technology is completely covered by COM3LAB-Multimedia. The COM3LAB-Course Transmitter Technology gives a deep insight into the conception and into the modes of operation of modern data- and broadcast transmitters. Spectra and oscillograms are measured and evaluated for analog modulated signals.



Wireless data transmission

The subject receiver technology explains the principles of modern broadcast receivers and their demodulation principles. Together with the COM3LAB-Course Transmitter Technology, a wireless communication can be established. The transmitter works on the license free frequency band at 433 MHz and produces a RF power of harmless 10 mW. The COM3LAB-Course Operational Amplifiers contained in this equipment set gives the basics of analog circuitry necessary for the understanding of transmitter and receiver technology.

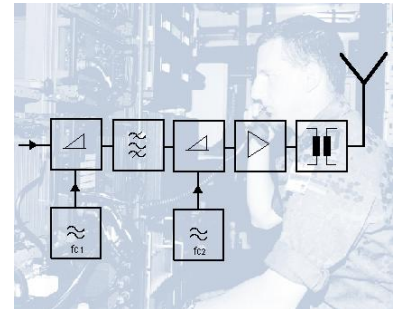

Transmitter technology is widely spread in commercial, military and security services.

EQUIPMENT LIST T 7.3

COM3LAB-Multimedia: Transmitter Receiver Technology

Quantity	Cat.-no	Description
1	700 00	Master Unit
1	700 71	COM3LAB course: Transmitter Technology
1	700 72	COM3LAB course: Receiver Technology
1	700 81	COM3LAB course: Operational Amplifiers

A complete material list including accessories is available on request.

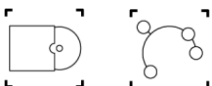

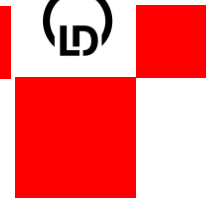

RF Technology

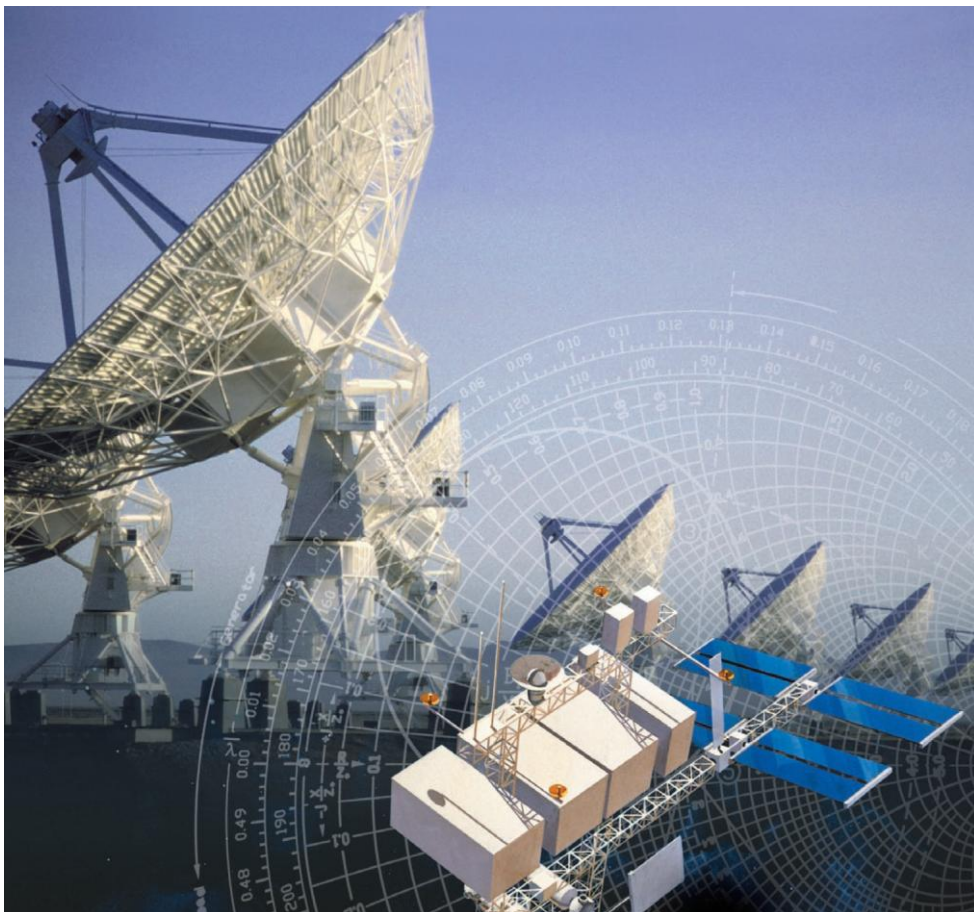

Total Overview

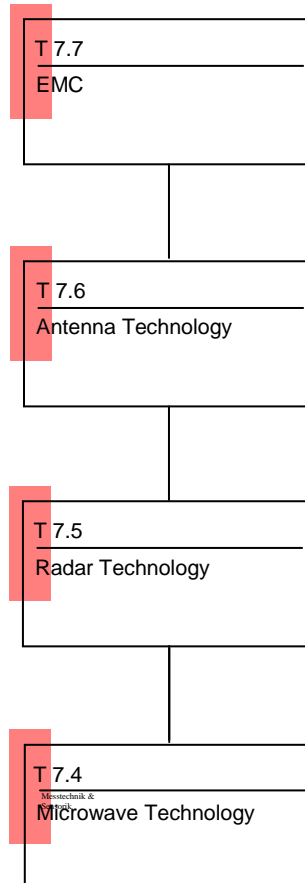

RF Technology – four topics with the same roots

Many components of the following laboratories are used in different experiments (Gunn oscillator, antennas, Sensor-CASSY, etc). This makes it possible to minimize the scope of items combined into individual sets if necessary. Repeatedly employed components need only be purchased once and then „loaned out“ to the given active experiment where they can be used again. All labs are produced at site in Huerth, Germany.

RF Technology, what is it?

RF technology (high frequency = radio frequency) consists of the following sub-fields:

- Microwave Technology
- Radar Technology
- Antenna Technology
- EMC

By including sonar, these fields then encompass a frequency range of 7 decades – from about 30 kHz up to 300 GHz. The operation, maintenance and planning of commercial systems in such an expansive frequency range require a variety of skills in testing techniques and functional principles. Though these diverse fields do have much in common – for example reflections, echoes, standing waves and adaptation are universal problems that occur in all disciplines – they also demand different measuring techniques and interpretations.

RF Technology, who needs it?

Global communications as well as mass traffic flows, whether on the road or in the air, require capable RF systems. Mobile communication networks, satellite communications, traffic routing, air control, navigation services, GPS are all applications which depend on the trouble-free operation of their RF modules.

RF Technology and LD Didactic!

Our selection of RF training systems is as broad as the frequency range it covers. Our offering is uniquely diverse yet courses are structured to build on one another and to be complementary such that all relevant themes in RF technology are covered. Select from 16 different laboratories to configure your own training agenda. The study of RF technology with LD Didactic is not exhausted with the conventional subjects „waveguide technology“ and „dipole antennas“. We go further to provide an overall concept that reflects state-of-the art technology.

Some Technical Details

Hardware

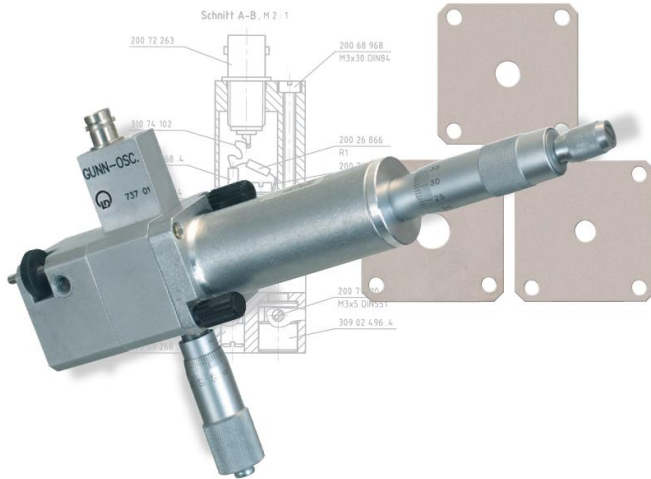

The quick-change artist

The Gunn oscillator serves as a microwave source for many experiments and many different equipment sets. In combination with other components (movable short, diaphragms, etc.), the frequency and power of this source can be varied.

Modularity

Experiments are performed with waveguide, microstrip line or coaxial components. Many of these mechanically robust components can be disassembled and modified. This promotes deep insight into fundamental principles.

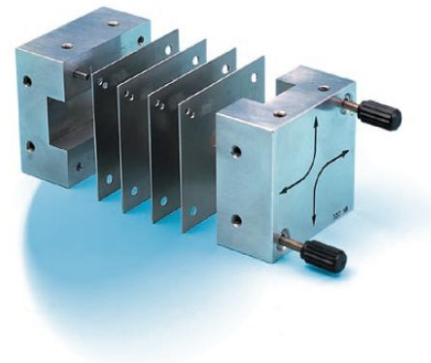

Materials

Waveguide components made of solid aluminum or brass guarantee robustness in everyday laboratory usage (the illustration shows the slotted measuring line 737 111 as an example). Precise fabricating processes result in tight tolerances (backlash, surface roughness, flange offset). Component surfaces are passivated or protected against corrosion by nickel plating. Waveguides comply with the international standard R100. Flanges are compatible with UBR100.

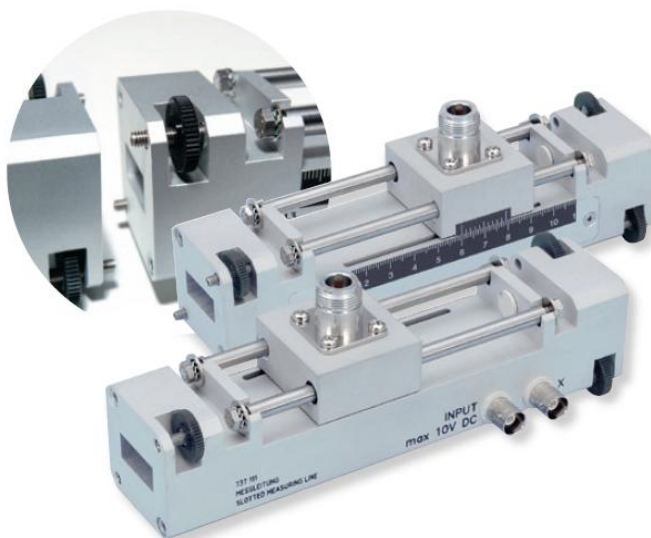

Some Technical Details

Didactic Concept

LD educational systems for RF technology have the following objectives:

- To explain physical effects
- To promote familiarity with individual components
- To provide a means of building microwave circuits
- To realize projects by integrating various systems from microwave, antenna and communications technology.

Training systems are conceived for different training programs. Target groups are:

- Universities
- Vocational schools
- General education and occupational schools
- Government and industry training facilities

Conventional education systems are frequently compiled on the basis of finished commercial products. Therefore these only permit „black box“ examinations. What takes place inside the devices remains a mystery to the student. Our systems afford an opportunity to rebuild important RF components thus permitting a unique view behind the scenes.

Equipment Sets

Microwave Technology

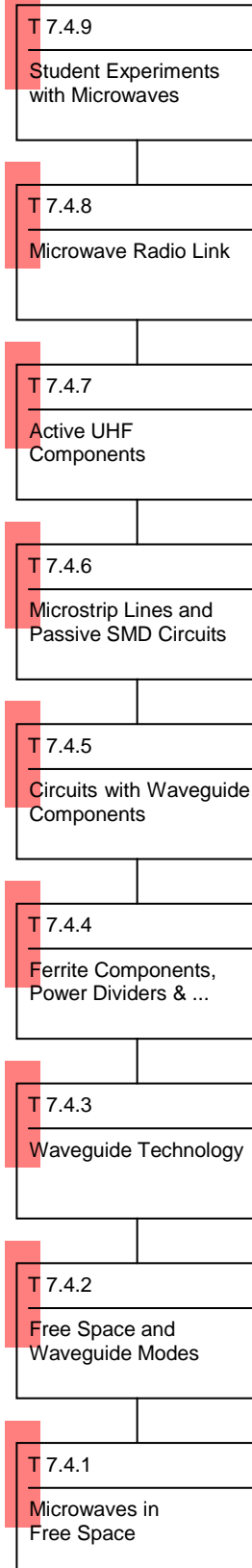

Equipment Sets

Microwave Technology

T 7.4.1 Microwaves in Free Space

The basics of microwaves in free space are investigated here. Polarization, diffraction, reflection etc. are the subject matter.

T 7.4.2 Free Space and Waveguide Modes

Radio waves in free space and in waveguides exhibit different characteristics. Determination of the cut-off wavelength.

T 7.4.3 Waveguide Technology

Classic experiments in microwave technology with waveguide components in the X-band at 9.4 GHz. Many of the components used here reveal interesting, didactic details.

T 7.4.4 Ferrites, Dividers & Active Elements

This equipment set expands and deepens the awareness of waveguide components. Investigations include non-reciprocal components, magic-T and PIN modulator.

T 7.4.5 Circuits with Waveguide Components

Circuits with waveguide components will be configured. This course places the technical application into the foreground.

T 7.4.6 Microstrip Lines and SMD Circuits

RF circuits with microstrip components are fabricated in PCB technology. Filters, power dividers and directional couplers can be etched directly onto the printed circuit board. An extensive lab with many test objects for measurements in the UHF range between 260 MHz and 520 MHz with a vector network analyzer.

T 7.4.7 Active UHF Components

Active and non-reciprocal elements, such as MMIC amplifier, circulator and PIN diodes are investigated with the network analyzer.

T 7.4.8 Microwave Radio Link

A setup for a PCM transmission link with microwaves. This is done by combining components from the fields of waveguide technology, antenna technology and transmission technology. A real project!

T 7.4.9 Student Experiments with Microwaves

An introductory package for student practice with the subject of electromagnetic waves in free space.



Microwave Generation

Computer Based Training

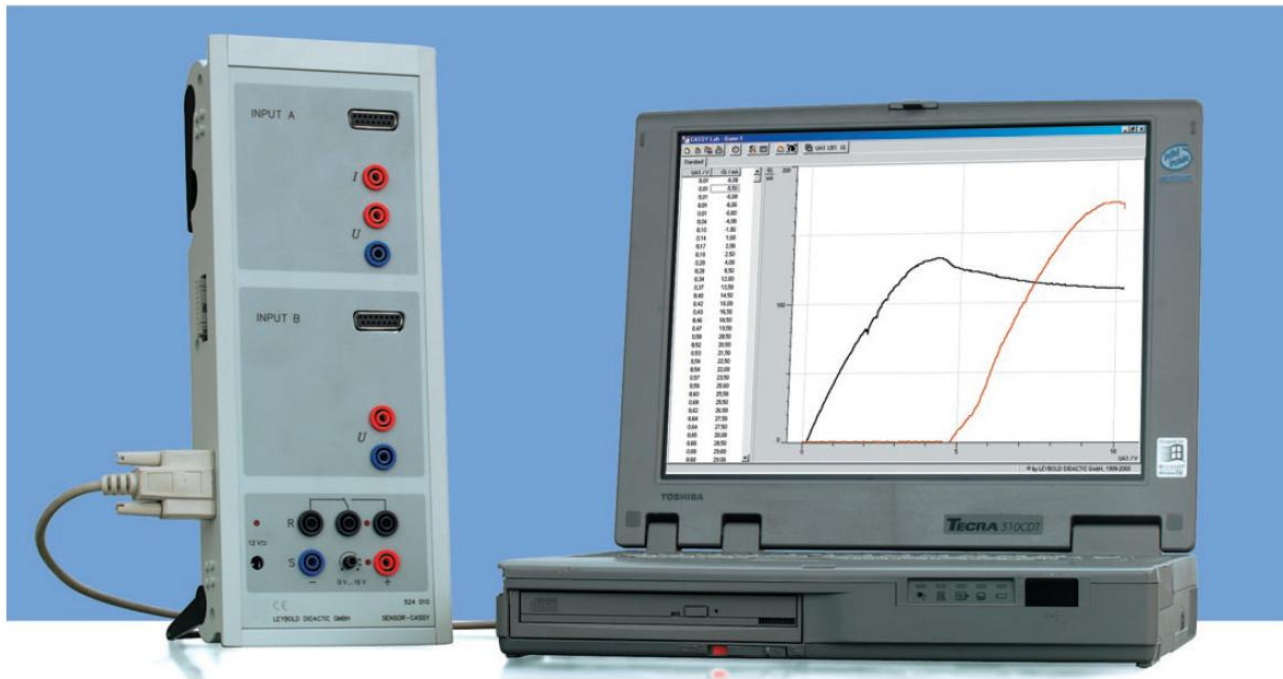

Computer based experimentation as exemplified by recording the characteristic of a Gunn oscillator. The current/voltage curve (black) of the Gunn oscillator shows a range with negative slope (falling part of the characteristic). Only in this part of the characteristic will the losses of the resonator be compensated to produce microwave energy (red line). As is the case with this example, all experiments can be evaluated with Sensor-CASSY.

Documentation

Comprehensive documentation in the form of experiment handbooks or multimedia training programs and CBT (Computer Based Training) supported microwave experiments are available for all microwave training systems in the T 7.4 program. Together with Sensor-CASSY and CASSY Lab 2 software, key experiments can be called up easily with their default settings. Some CBT experiments utilize new CASSY Lab 2 calibration functions that substantially simplify work with microwave components. CASSY makes it possible to perform evaluations with direct comparison of respective theoretical field behavior that produce impressive results.



Microwave Generation

A Typical Setup

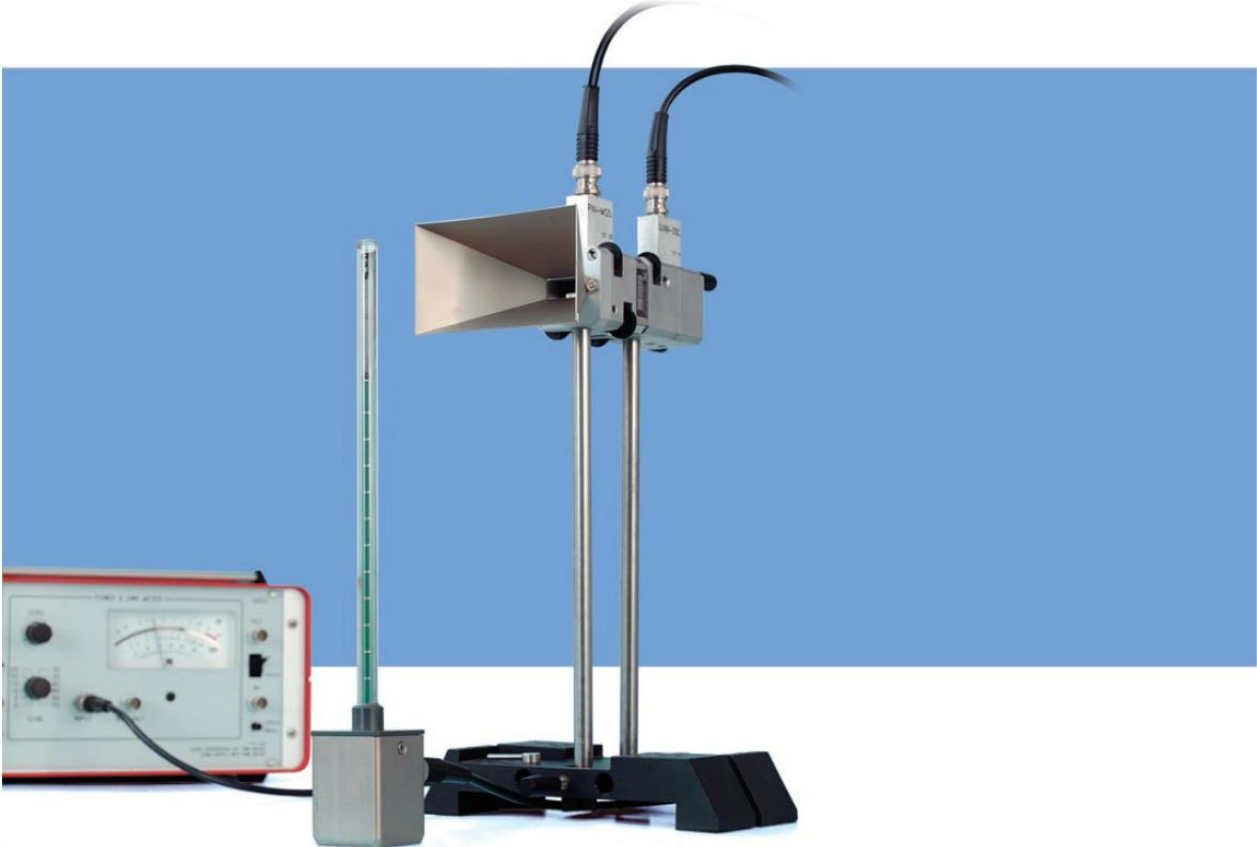

The **Gunn oscillator** generates the microwave signal:

- Power: $P_0 = 10 \text{ mW}$
- Frequency: $f_0 = 9,4 \text{ GHz}$
- Wavelength: $\lambda_0 = 32 \text{ mm}$ (in free space)

Low RF power means no danger in experiments with microwaves. Additionally, detectors operate in the square law region. An **isolator** prevents reflections from reaching the Gunn oscillator. The **PIN modulator** carries out the modulation for AC detection. The **horn antenna** radiates waves into free space. The microwave receiver consists of an E-field probe and a sensitive lock-in-amplifier. The central operating unit in all microwave experiments is the **Gunn Power Supply with SWR Meter** (737 021). It contains:

- DC power supply for the Gunn oscillator
- PIN modulator control
- Lock-in-amplifier
- Broadband amplifier for signal transmission

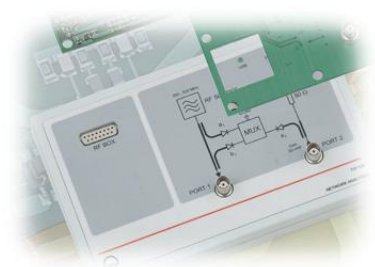

T 7.4.1 Microwaves in Free Space – Physical Principles



The propagation of microwaves in air takes place according to pseudo optical laws. The free-space experiment illustrated here is typical for this equipment set. It consists of a microwave transmitter and receiver and sometimes an element which influences the beam's transmission (in this case a polarizer).

Topics (selection)

- Characteristics of the Gunn Element
- The E-field probe
- The selective measuring amplifier
- Field in front of a horn antenna
- Interference and standing waves
- Reflection and transmission
- Absorption, diffraction, polarization
- Flexible waveguide
- Doppler effect

T 7.4.1. Microwaves in Free Space – Physical Principles

Microwaves in free space exhibit optical properties. This course investigates known phenomena like e.g. polarization, diffraction and reflection.



In detail: E-field probe

A good RF field probe may not interfere with the field being measured. This is why metal conductors are not permitted in the vicinity of the detector. In particular, expansive reflectors are a total RF sin. Reflections caused there would immediately distort the original field. Therefore our E-field probe operates with metal-free feeds made of highly-resistive graphite.

Commercial free-space transmission with microwaves

Cellular networks are conquering the world. Their air interfaces depend strongly on microwave and antenna technology.

EQUIPMENT LIST T 7.4.1

Microwaves in Free Space – Physical Principles

Quantity	Cat. No.	Description
1	737 01	Gunn Oscillator
1	737 021	Gunn Power Supply with SWR Meter
1	737 05	PIN Modulator
1	737 06	Isolator
1	737 21	Large Horn Antenna
1	737 27	Physics Microwave Accessories I
1	737 35	E-Field Probe
1	524 013S	Sensor-CASSY 2 Starter
1	568 722	Book: Microwaves in Free Space – Physical Principles

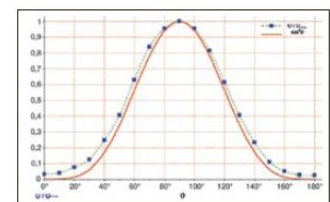

Polarizing microwaves

Malus's law describes intensity distribution in conjunction with the polarizer's orientation. Since the E-field probe itself is directionally sensitive in its operation, a dependency approx. $\approx \sin^4 \varphi$ results.

An actual material list including accessories is available on request.

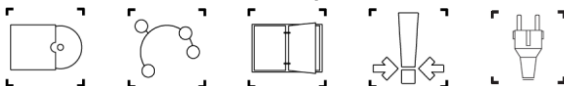

T 7.4.2 Free Space- and Waveguide Modes

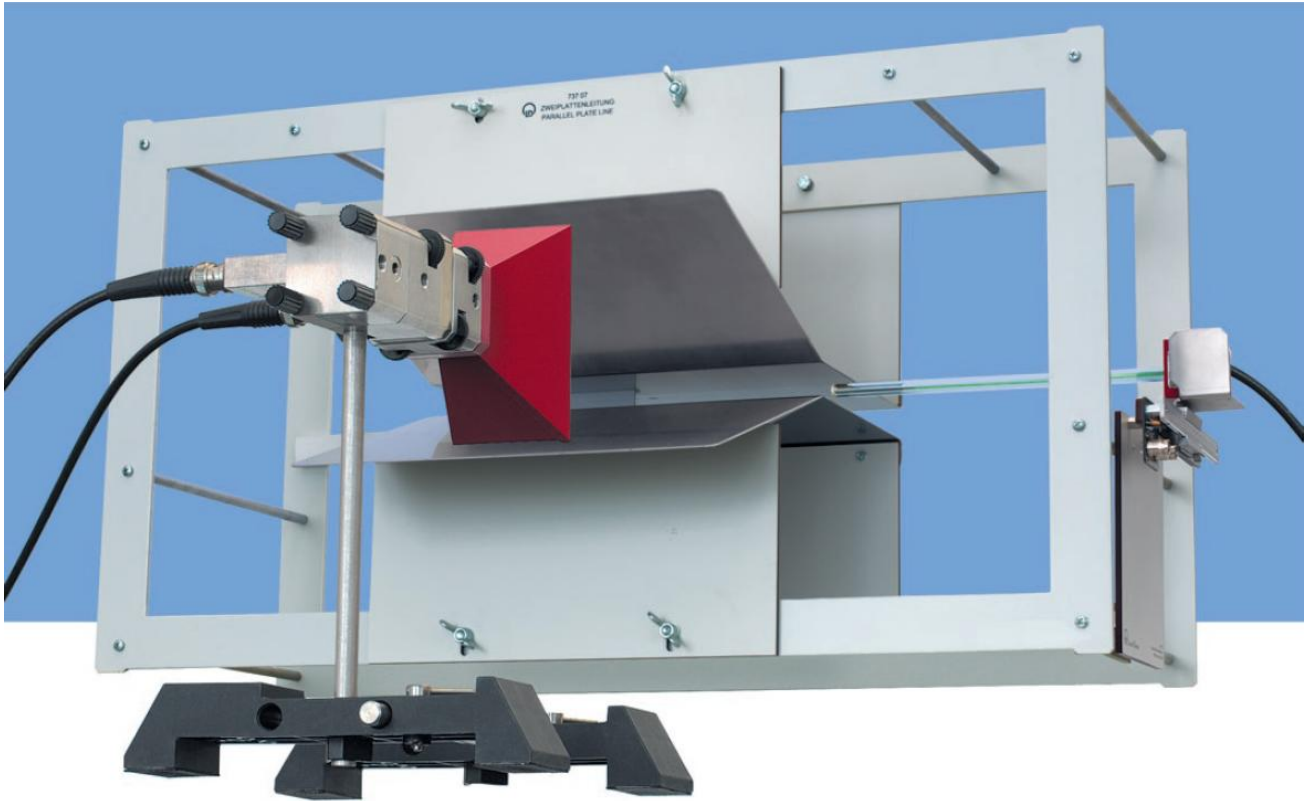

The parallel plate line combines the features of a lecher line and a rectangular waveguide.

Topics

- Propagation of TEM- and TE-waves
- Standing TEM- and TE-waves
- Determination of the cut off wavelength
- Absorbers
- Dissipative and reactive attenuation
- Humidity measurement

T 7.4.2. Free Space – and Waveguide Modes

Depending on the polarization of the excited microwave field, the parallel plate line shows either characteristics of a Lecher line (TEM mode) or a waveguide (TE mode). It all depends on the orientation of the Gunn oscillator (longitudinal rotation by 90°).

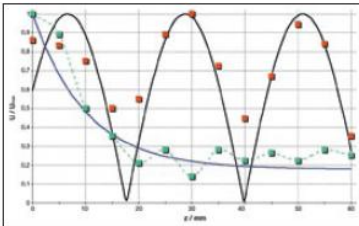

TE excitation

In the waveguide mode of the parallel plate line, no waves can propagate between the plates if the gap becomes smaller than $d < \lambda_0/2$ (see exponentially decaying field trend). For $d > \lambda_0/2$ an unattenuated standing wave results with a wave-length λ_G longer than λ_0 ($\lambda_G > \lambda_0$).

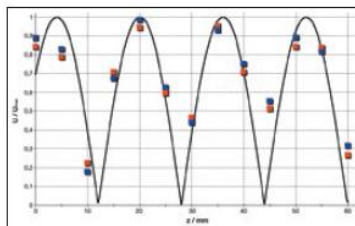

TEM mode

If the parallel plate line is operated as a Lecher line, then the wave propagation is independent of the plate gap (see unattenuated standing wave). The wavelength always corresponds to the value λ_0 in free space.

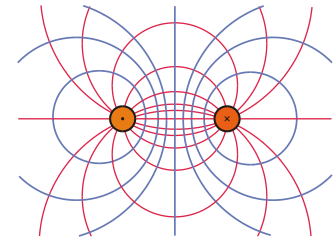

Field distribution in the parallel line

EQUIPMENT LIST T 7.4.2

Free Space – and Waveguide Modes

Quantity	Cat. No.	Description
1	737 01	Gunn Oscillator
1	737 021	Gunn Power Supply with SWR Meter
1	737 05	PIN Modulator
1	737 06	Isolator
1	737 075	Parallel Plate Line with Measuring Carriage
1	737 21	Large Horn Antenna
1	737 35	E-Field Probe
1	524 013S	Sensor-CASSY 2 Starter
1	568 662	Book: Free Space – and Waveguide Modes



Microwaves in industry and research

Researchers for industry and the sciences make broad use of RF technology applications. It is good to understand its rules!

An actual material list including accessories is available on request.

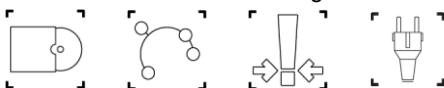

T 7.4.3 Waveguide Technology

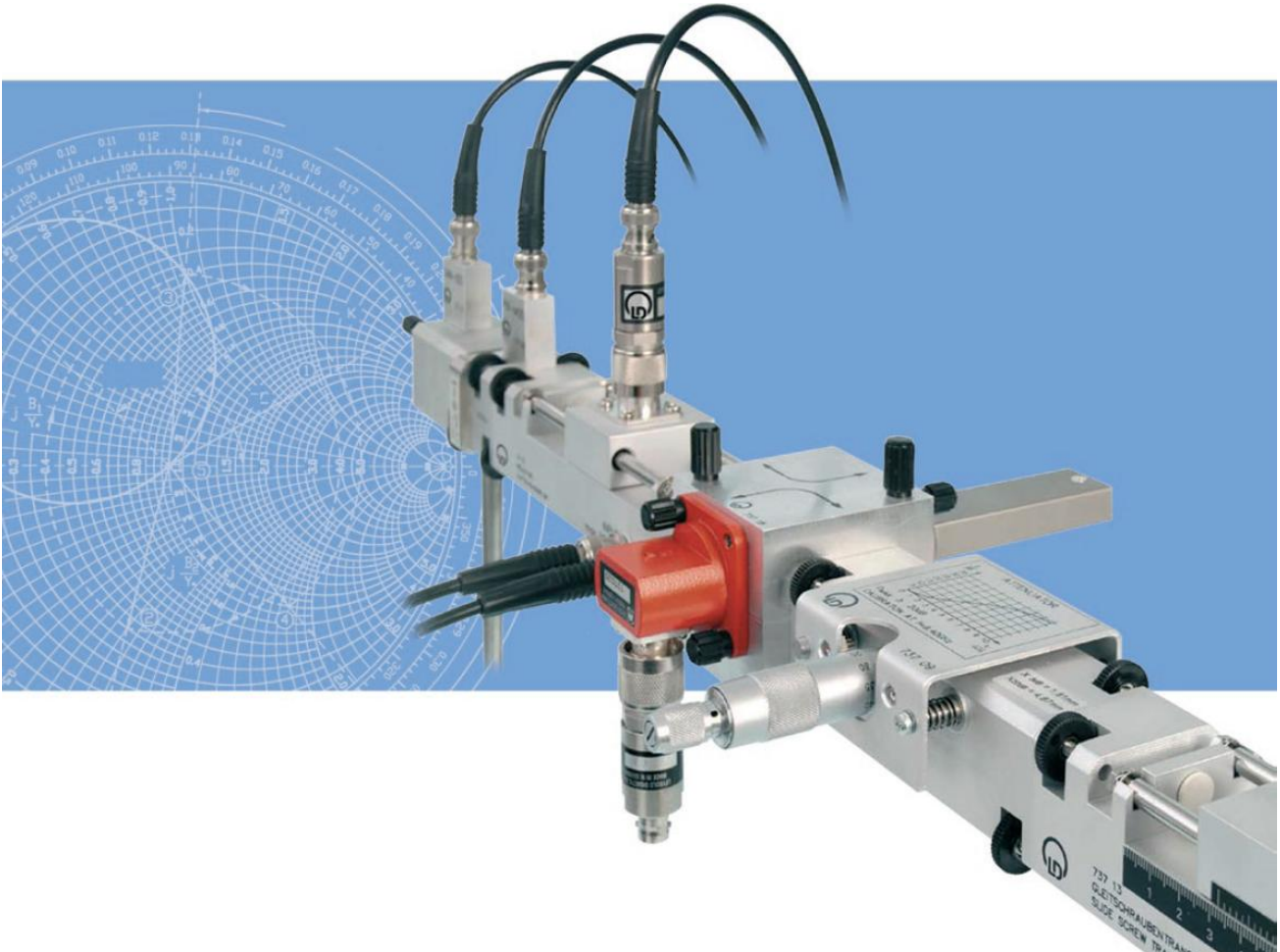

The units presented here provide a basis for well founded utilization of microwave components. The experiments convey an understanding for the function of active and passive components. They also create a point of reference for real applications. Even demanding themes, such as determination of reflection factors or investigating waveguide resonators, are treated.

Topics

- Gunn oscillator
- Power measurement
- Attenuators
- Frequency and wavelength
- Directional coupler
- Reflectometer
- Complex reflection factor
- Matching
- Reflection of single slots
- Cavity resonator

T 7.4.3 Waveguide Technology

The slotted measuring line contains an integrated displacement sensor that permits direct graphic presentation of standing waves, reflections, field trends, etc. when used together with a Sensor-CASSY.

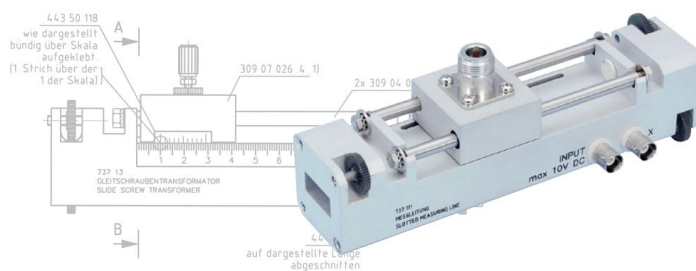

EQUIPMENT LIST T 7.4.3

Waveguide Technology

Quantity	Cat. No.	Description
1	737 01	Gunn Oscillator
1	737 021	Gunn Power Supply with SWR Meter
1	737 03	Coax Detector
1	737 035	Transition Waveguide / Coax
1	737 05	PIN Modulator
1	737 06	Isolator
1	737 09	Variable Attenuator
1	737 10	Moveable Short
1	737 111	Slotted Measuring Line
1	737 12	Waveguide 200 mm
(1)	737 13	Slide Screw Transformer
1	737 135	3-Screw Transformer
2	737 14	Waveguide Termination
1	737 18	Cross Directional Coupler
1	737 29	Waveguide Propagation Accessories
(1)	737 35	E-Field Probe
1	737 399	Set of 10 Thumb Screws M4
1	524 013S	Sensor-CASSY 2 Starter
1	568 732	Book: Waveguide Technology
()		recommended

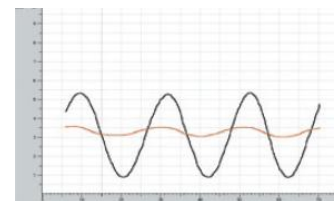

Matching

Attenuator and movable short form a complex load whose reflection factor can be adjusted in terms of magnitude and phase. A slotted measuring line is used to directly produce a graphic evaluation of the field distribution in the waveguide as a standing wave (black curve). Mismatching can then be significantly reduced (red curve) by adjusting the slide screw transformer.

An actual material list including accessories is available on request.

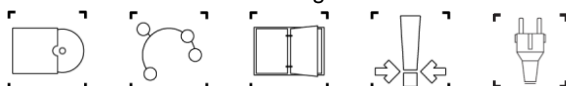

T 7.4.4 Ferrite Components, Power Dividers and Active Elements



The magic-T is a hybrid-T fitted with matching stubs. The illustrated experiment is used to determine coupling losses.

Topics

- PIN modulator
- Phase shifter
- Magic T
- Isolator
- Circulator

T 7.4.4 Ferrite Components, Power Dividers and Active Elements

Sophisticated RF systems need components that are able to take advantage of some special effects. For example, non-reciprocal elements like the isolator or the circulator are used to decouple oscillators from reflecting loads. These components often serve to realize duplexers in radar applications. Using the magic-T, balanced mixers and vector adders can be built.

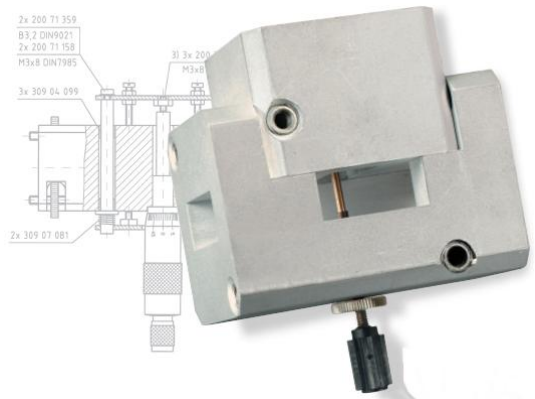

EQUIPMENT LIST T 7.4.4

Ferrite Components, Power Dividers and Active Elements

Quantity	Cat. No.	Description
1	737 01	Gunn Oscillator
1	737 021	Gunn Power Supply with SWR Meter
1	737 03	Coax Detector
1	737 035	Transition Waveguide / Coax
1	737 05	PIN Modulator
1	737 06	Isolator
1	737 065	Circulator
1	737 09	Variable Attenuator
1	737 111	Slotted Measuring Line
1	737 12	Waveguide 200 mm
3	737 14	Waveguide Termination
1	737 17	Phase Shifter
1	737 18	Cross Directional Coupler
1	737 0195	Magic T
1	737 29	Waveguide Propagation Accessories
1	524 013S	Sensor-CASSY 2 Starter
1	568 752	Book: Ferrite Components, Power Divider & Active Element

An actual material list including accessories is available on request.

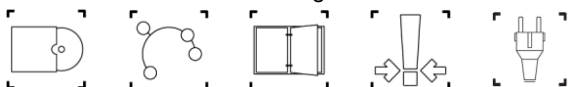

Microwaves and space travel

RF technology is certainly at home in the space travel environment. Communications between ground stations and satellites in orbit are accomplished with complex microwave systems.

T 7.4.5 Circuits with Waveguide Components



All of the microwave components in this equipment set are needed to permit the set up of extensive experiments and rather complex circuits. Emphasis now is no longer on the individual components but rather on the overall setup.

Topics

- Oscillator tuning
- Gunn oscillator with dielectric tuning
- Modulation
- Frequency conversion

T 7.4.5 Circuits with Waveguide Components

The function of the microwave components in this equipment set is already known. Emphasis is no longer on the individual components but rather on the overall setup.

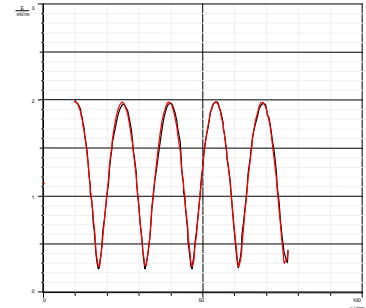

CASSY Lab 2

Frequency tuning is measured by evaluation of standing waves.

EQUIPMENT LIST T 7.4.5

Circuits with Waveguide Components

Quantity	Cat. No.	Description
1	737 01	Gunn Oscillator
1	737 015	Dielectric Tuning Unit
1	737 021	Gunn Power Supply with SWR Meter
1	737 03	Coax Detector
1	737 035	Transition Waveguide / Coax
1	737 05	PIN Modulator
1	737 06	Isolator
1	737 09	Variable Attenuator
1	737 10	Moveable Short
1	737 111	Slotted Measuring Line
1	737 12	Waveguide 200 mm
1	737 16	Frequency Meter
1	737 29	Waveguide Propagation Accessories
1	737 399	Set of 10 Thumb Screws M4
1	524 013S	Sensor-CASSY 2 Starter
1	568 692	Book: Circuits with Waveguide Components

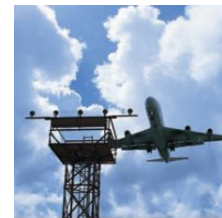

Air traffic and RF technology

The continuously expanding volume of air traffic cannot operate safely without the approval of efficient air traffic control. But even on-board, the exchange of data between systems must be handled by ever-faster carrier frequencies.

An actual material list including accessories is available on request.

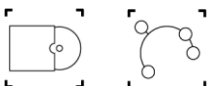

T 7.4 Multimedia Microwave Lab

Description

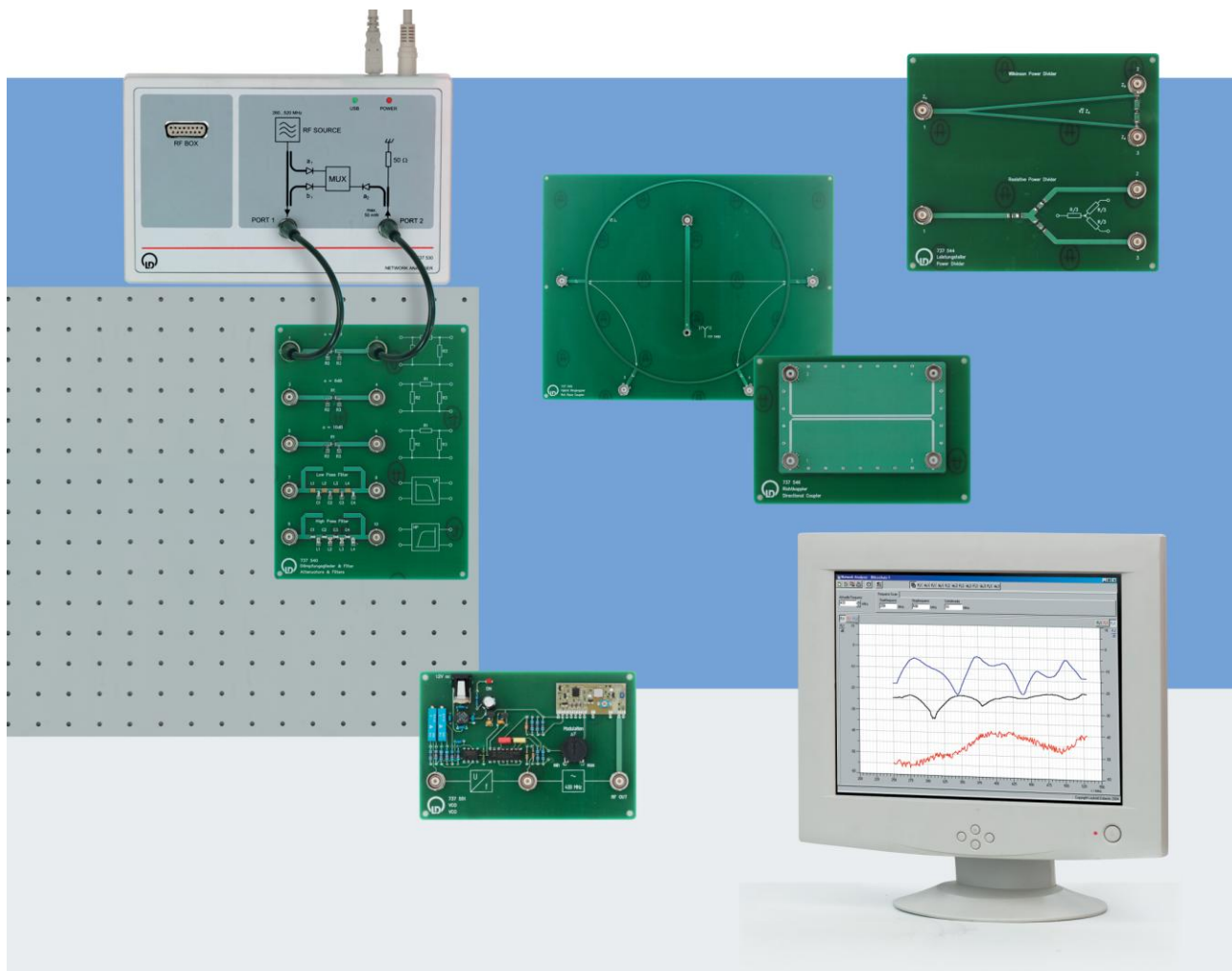

The trend toward miniaturization and reduced production costs has strongly influenced the design of RF components. Printed circuit boards, microstrip lines and surface mounted devices have become standard for applications involving intermediate frequencies and low-power in many fields:

- Cellular phone technology
- Satellite communications
- Radar
- Navigation systems
- Medical technology
- Radio data transmission
- WLAN etc.

The microstrip lines and passive SMD circuits in T 7.4.6 and active UHF circuits in T 7.4.7 allocated to COM3LAB courses investigate both individual components as well as small systems in the UHF range. The experiments include theory, performing experiments, and interpretation. They are described on the COM3LAB multimedia CDs.

T 7.4 Multimedia Microwave Lab

Features

- Multimedia supported experiment courses
- Easy startup
- Ideal for instructor demonstration and student practice
- Vector network analyzer
- Integrated evaluation functions
- Presentations in Smith chart and Bode plot
- Many test samples, about 30 passive and active circuits
- Newest MMIC technology
- Comprehensive theme list

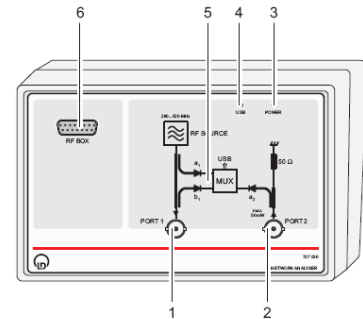

Network analyzer

The center-point of this training system is the vector network analyzer.

- 1 Port 1: RF generator output
- 2 Port 2: Input for transmission measurements
- 3 Input for supply voltage, with LED indicator
- 4 USB port with LED indicator
- 5 Block diagram with signal separation and multiplexer
- 6 Port for RF boxes

Technical Data

Frequency range	260 MHz ... 520 MHz
Frequency resolution	10 kHz ... 10 MHz
Phase resolution	1°
Output power, port 1	about +3 dBm (2 mW)
Input power port 2	Max. +17 dBm
Dynamic response	S11 > 25 dB, S21 > 50 dB
Operational modes	Sweep / CW / standing waves / RF switch
Evaluations	Mean values, marker, zoom
Presentation formats	Bode diagram with separate plots for magnitude/phase in Cartesian coordinates. Magnitude in lin/log presentation. Smith chart; the circular diagram with composite representation of magnitude and phase. Tabular display of measurement values. Display of complex reflection factor Γ and complex impedance Z .
Supply voltages	+5 V, ± 15 V
Dimensions	210 mm x135 mm x45 mm
Mass	400 g
Power adapter	100 V ... 240 VAC, 50/60 Hz

Connections

RF box	15-pin sub-D for connecting the NWA box
Port 1	BNC
Port 2	BNC
PC	USB

T 7.4 Multimedia Microwave Lab

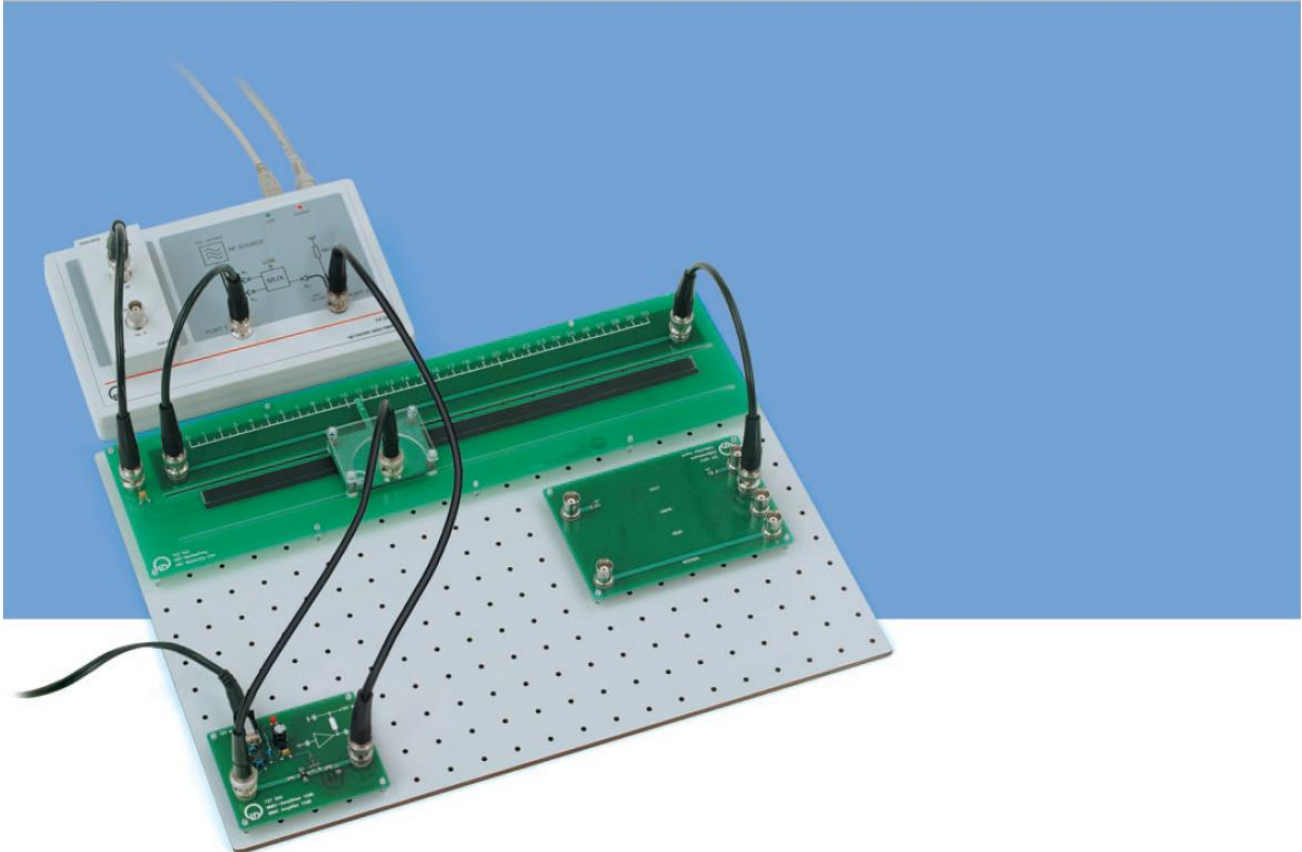

The primary function of the network analyzer is to record frequency responses in the form of Bode plots or Smith charts, as illustrated in the following screenshots. However, this device can also be used as an adjustable RF generator. This mode of operation permits classic measurements with the slotted measuring line and entirely new measurements on PIN diodes. The illustration shows the network analyzer and the UHF slotted measuring line. The UHF slotted measuring line has an integrated displacement sensor. This directly produces measurement diagrams without bothersome evaluation of measurement tables. The multimedia microwave laboratory is a professional practice course that requires no further accessories other than a PC. It uses the same software environment as the LD COM3LAB courses, but does not require the Master Unit (700 00). Thus the multimedia microwave lab is a real representative of the COM3LAB philosophy:

COM3LAB

- Compact
- Complete
- Computerized

T 7.4 Multimedia Microwave Lab

The majority of measurement objects is built on printed circuit cards that contain circuit elements in the following technologies:

- SMD
- Microstrip line
- Strip line
- Coaxial elements.

All test objects are fitted with BNC sockets. The sample shown is a PCB card for attenuators & filters with symmetric π -attenuator elements (3/6/10 dB) as well as low-pass and high-pass filters.

Measurement objects



CASSY Lab 2's proven software environment makes child's play out of dealing with the network analyzer. The illustration shows a SOLT calibration for the standards:

- Short circuit (black curve)
- Open (blue curve)
- Load (no reflection, green curve)
- Through (brown curve)

SOLT calibration

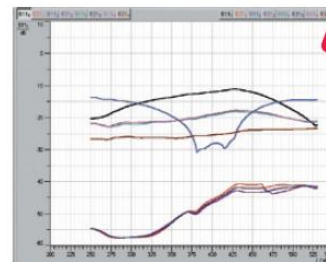

Professional instrumentation

To evaluate the calibration, the throughput line (Through) on the calibration board will be measured again and subsequently corrected by the above-displayed SOLT measurement:

- red curve: insertion loss (corrected to 0 dB)
- black curve: return loss of about -28 dB

Result: Calibration reduces systematic faults in the measurement system substantially. The anticipated characteristics of test objects become much clearer.

Reference measurement

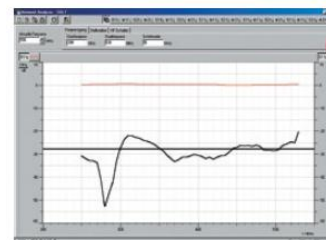

Professional instrumentation

T 7.4.6 Microstrip Lines and Passive SMD Circuits

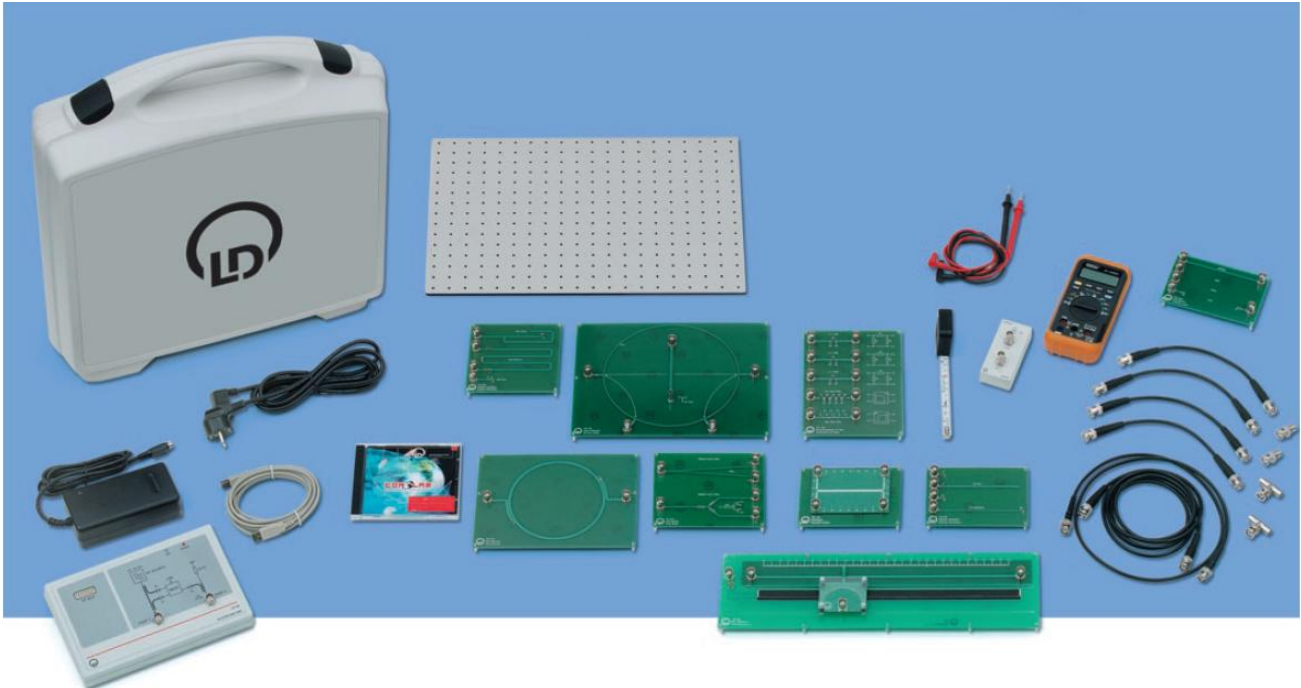

Topics (selection)

- Display formats for network analyzers,
- Smith chart and Bode plot
- Reference plots and SOLT calibration
- π filters
- Stubs as reactive elements
- Return loss of resistive terminations
- Bode plots & matching conditions
- $\lambda/4$ stub and the $\lambda/4$ transformer
- Matching with open end parallel stub
- Line resonators
- Equivalent circuits and CAD simulation
- SWR for different line terminations
- Assessing λ by open/short comparison
- Shifting the standing wave by line elongation
- Measuring λ for different frequencies
- Phase trend in a standing wave
- Wilkinson dividers and resistive dividers
- Insertion loss of power dividers
- Determining coupling loss and isolation
- Directional coupler investigations

T 7.4.6 Microstrip Lines and Passive SMD Circuits

The COM3LAB course Microwave Technology I is a completely equipped multimedia training course. It conveys an understanding for elementary assemblies and the most modern measuring techniques for radar systems, satellite communications and wireless networks. Measurements are performed with a vector network analyzer and with a classic measuring line. Passive UHF circuits made with microstrip lines and SMD components serve as test objects.

Smith chart measurements are only possible if additional to the magnitude, the phase transfer function of the device under test is measured. And this requires a **vector** network analyzer. Where standard training systems at the best can deal with a tuneable microwave synthesizer, LD offers the full information of the phase and magnitude necessary for Bode plots and Smith charts.

EQUIPMENT LIST T 7.4.6

Microstrip Lines and Passive SMD Circuits

Quantity	Cat. No.	Description
1	737 51	COM3LAB Course: Microwave Technology Within the scope of delivery of 737 51:
1		Network Analyzer incl. power supply and USB cable
1		Network Analysis Accessories
1		Attenuators & Filters, π attenuators 3/6/10 dB low-pass and high-pass filter
1		Resistive Terminations, reflex free termination, ohmic mismatch 2R, $\lambda/4$ -stub, $\lambda/4$ -transformer
1		Complex Terminations matching with parallel stubs line resonator
1		UHF Measuring Line, displacement range 30 cm, incl. displacement transducer
1		Power Dividers: Wilkinson type & resistive type
1		Rat Race Coupler
1		Directional Coupler, stripline technology
1		Ring Resonator
1		Multimedia Training Software

An actual material list including accessories is available on request.

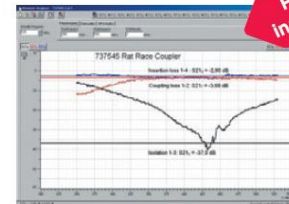
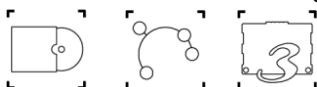

Professional instrumentation

Bode plot of a rat race coupler

Calibrated amplitude response in a frequency range from 260 MHz to 520 MHz:

- red curve: coupling losses
- black curve: isolation
- blue curve: insertion losses

Mean values and markers are used as evaluating functions.

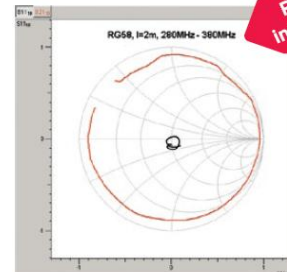

Professional instrumentation

Smith chart of a coaxial line

Real measurement! The Smith chart diagram is the composite depiction of magnitude and phase in a single polar diagram, here measured for the frequency range 300 MHz to 400 MHz:

- red curve: insertion losses
- black curve: reflection

T 7.4.7 Active UHF Components

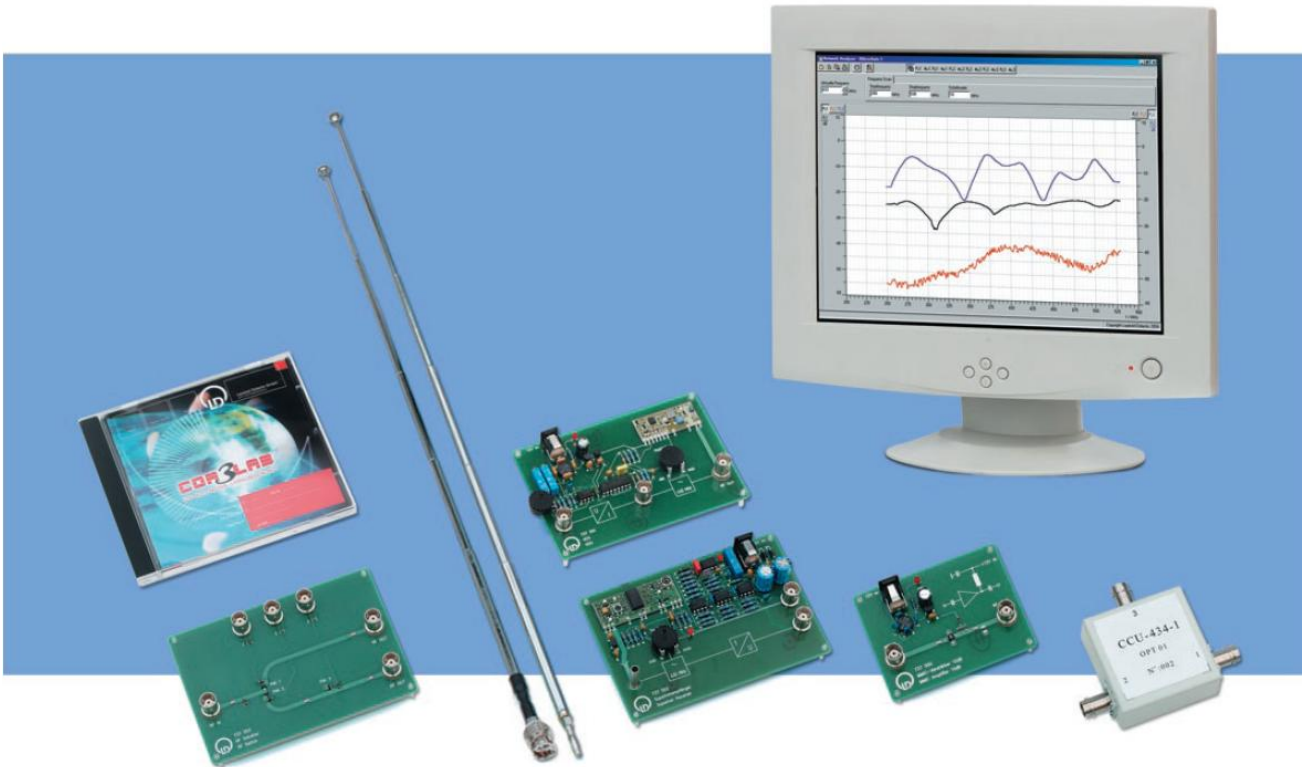

The equipment set „Active UHF Components“ expands on experiments performed on coaxial passive components and active SMD circuits. There is storage room for this set in the case provided with the COM3LAB course „Microwave Technology I“.

Topics (selection)

- Determining the resonance of rod antennas
- Insertion loss and stop band attenuation
- Circulator bandwidth
- Short circuited parallel stubs
- Transformation behavior of long lines
- Attenuation of coaxial lines, frequency dependence
- Calculation of dielectric constants from phase measurements
- Gain and return loss of an MMIC amplifier
- PIN diode switching behavior
- Microwave transmission link
- V/f and f/V converter characteristics
- Capture range of the superhet

T 7.4.7 Active UHF Components

Miniaturized SMD Components and active MMIC elements feature surprising properties. The switching behavior of an SPDT switch (Single Pole Dual Throw). This type of switch is implemented with PIN diodes. Subject to a DC bias current, it exhibits alternating transmission properties from its input to the two outputs at 433 MHz.

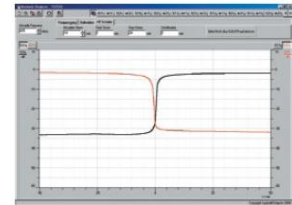

RF switches with PIN diodes

- red curve: negative control currents open the PIN diode (1). Positive control currents block.
- black curve: positive control currents open the PIN diode (2). Negative control currents block.

EQUIPMENT LIST T 7.4.7

Active UHF Components

Quantity	Cat. No.	Description
1	737 51	COM3LAB Course: Microwave Technology I
1	737 52	COM3LAB Course: Microwave Technology II
		Within the scope of delivery of 737 52
2		UHF Antenna
1		3-Port Circulator
1		MMIC Amplifier +10 dB. Output power max. 50 mW
1		VCO, operating frequency 433.92 MHz, FM modulation with integrated V/f converter
1		UHF Superhet Receiver, input frequency 433.92 MHz with integrated f/V converter
1		RF Switch, realized with PIN diodes in SPST and SPDT configuration

An actual material list including accessories is available on request.

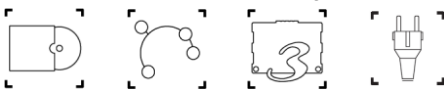

T 7.4.8 Microwave Radio Link



Experimental setup for signal transmission with microwaves. PCM base-band signals are modulated onto microwaves with the help of the PIN modulator. The parabola antennas convert the line-bound microwaves into free-space waves that make it possible to transmit signals from the transmitter to the receiver. The receiver restores the base-band signal through incoherent detection at the waveguide detector. The weak reception signal is sent to a broadband amplifier (VIDEO, section of the Gunn Supply with SWR meter 737 021).

Topics (selection)

- Setup of primary exciters for transmitter and receiver
- Aligning parabola antennas
- Matching for maximum signal reception
- Test for modulation demodulation equipment
- Commissioning the microwave link

T 7.4.8 Microwave Radio Link

One commercial application for microwave technology is the transmission of data via microwave links in e.g. wide area networks (WAN) as an economic alternative to cables and satellites. A combination of the training systems T 7.2.2.1 Pulse Code Modulation and T 7.4 Microwave Technology provides a laboratory set up for terrestrial microwave links which is closely associated with real systems.

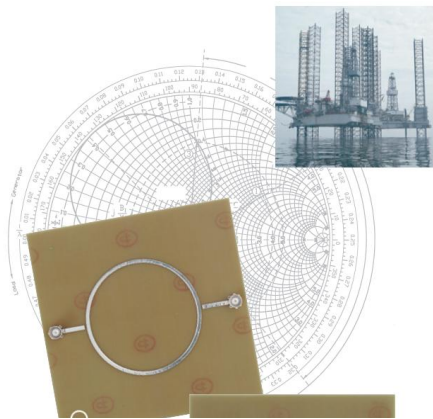

Crude oil from the sea

Microwave technology is common practice in oil production too. Offshore oil platforms in coastal areas are held precisely in place over their bore holes with the help of satellite-supported navigation systems (GPS = Global Positioning System).

EQUIPMENT LIST T 7.4.8

Microwave Radio Link, part 1: RF System

Quantity	Cat. No.	Description
1	737 01	Gunn Oscillator
1	737 021	Gunn Power Supply with SWR Meter
1	737 05	PIN Modulator
1	737 06	Isolator
1	737 08	Waveguide Detector
1	737 135	3-Screw Transformer
2	737 20	Small Horn Antenna
2	737 452	Dish Antenna
1	524 013S	Sensor-CASSY 2 Starter
1	568 692	Book: Circuits with Waveguide Components

Microwave Radio Link, part 2: Modulation

Quantity	Cat. No.	Description
1	736 061	PAM Modulator
1	736 071	PAM Demodulator
1	736 101	PCM Modulator
1	737 111	PCM Demodulator

An actual material list including accessories is available on request.

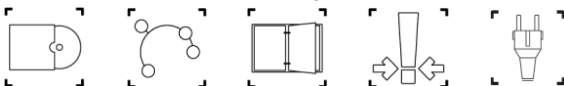

T 7.4.9 Student Experiments with Microwaves

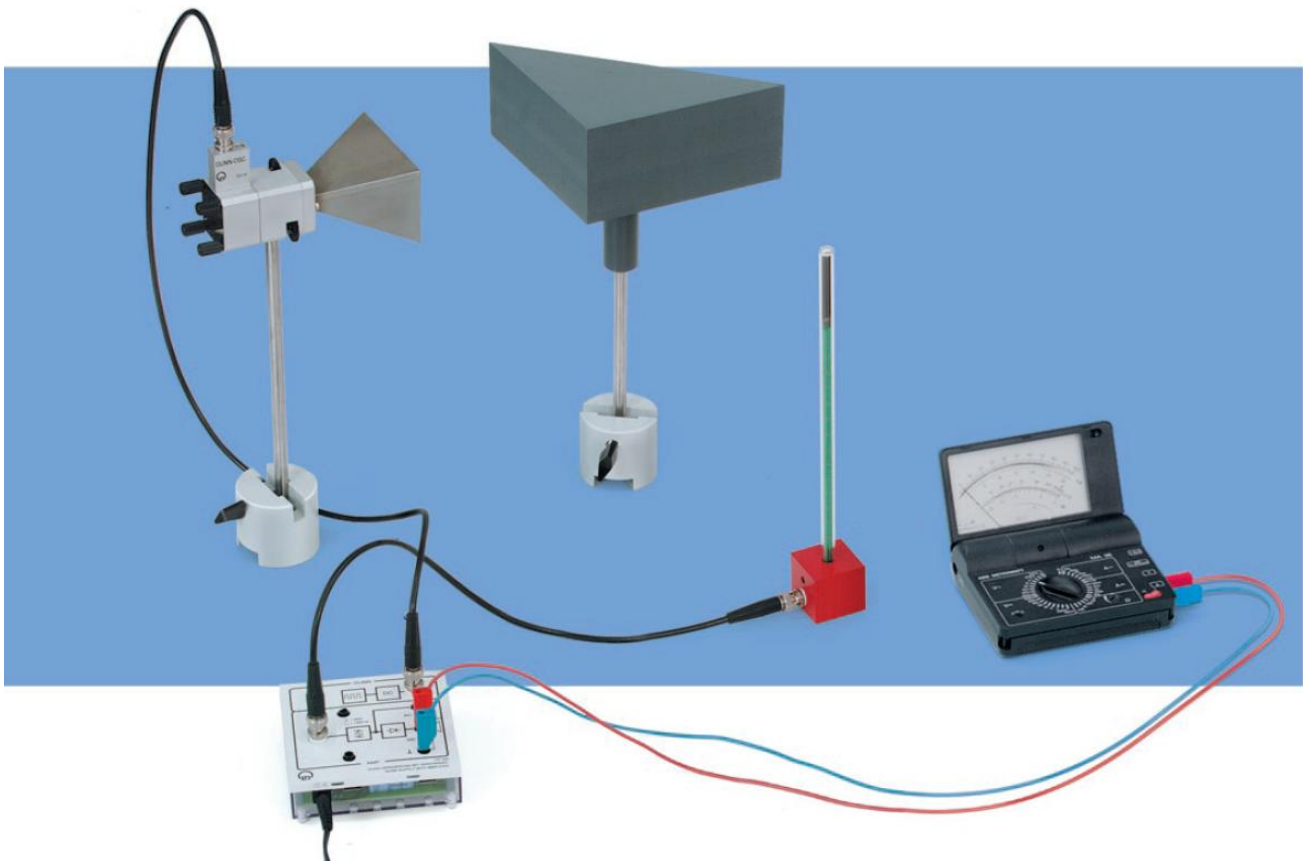

This equipment set provides an introductory package of student experiments that treats the subject of electromagnetic waves in free space without placing great emphasis on accuracy or interpretational background. The measurements are simply tabularized by hand and then worked out in writing.

Topics

- Gunn oscillator
- Basic properties of microwave fields
- Wave propagation in dielectric mediums
- Pseudo optic behavior of microwaves
- Wave propagation on transmission lines
- Applications for microwave technology

T 7.4.9 Student Experiments with Microwaves

EQUIPMENT LIST T 7.4.9

Student Experiments with Microwaves

Quantity	Cat. No.	Description
1	737 01	Gunn Oscillator
1	737 020	Gunn Power Supply with Amplifier
1	737 21	Large Horn Antenna
1	737 27	Physics Microwave Accessories I
1	737 275	Physics Microwave Accessories II
1	737 35	E-Field Probe
1	579 28	Loudspeaker with Transformer
1	599 312	Book: Experiments with Microwaves

An actual material list including accessories is available on request.

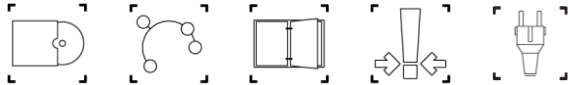

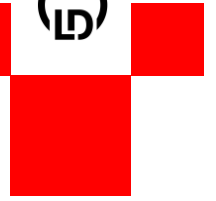

T 7.5 Radar Technology



Multimedia Radar Trainer

Equipment Sets

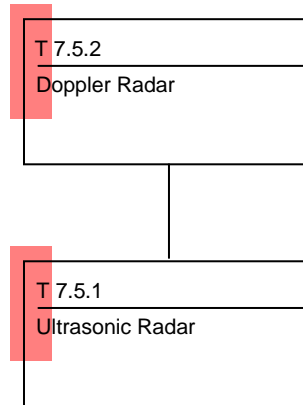

Radar technology within two COM3LAB courses

As a leading manufacturer of RF technology training systems, we have put our experience to work to develop a completely new radar trainer. This multimedia radar trainer operates with the well-known software platform from the COM3LAB-Courses, but it requires no Master Unit (700 00).

The radar trainer investigates the function and applications of modern primary and secondary radars through experiments. From civil air traffic control and air-traffic control with friend/foe identification (IFF) to coastal radar and the protection of property, all topics are discussed with an unsurpassed number of interesting experiments. The multimedia format used to present the theory, test practices and interpretations is entirely new in the field of radar trainers. The radar trainer is installed in the lab. That is why it only requires a low range but boasts high spatial resolution. The vehicle velocities for the Doppler-radar are also within the low range, standard for the lab. For safety reasons, the radar trainer operates with low power and sound-pressure levels. While commercial-based training systems may pose a danger, there is no potential danger with this radar trainer. As a subsection of the LD training systems for RF technology, the radar trainer makes use of components from microwave and antenna training systems.

Multimedia Radar Trainer

General Notes

The main emphasis of the two COM3LAB courses is concentrated on the following topics:

- Physics of radar technology
- Technical implementation of radar systems
- Tactical experiments with radars.

The Multimedia Radar Trainer is divided in two kits:

- T 7.5.1 Ultrasonic Radar
- T 7.5.2 Doppler Radar

Recommended additional courses:

- T 7.4.3 Waveguide Technology
- T 7.4.4 Ferrite Comp., Power Div. & Active Elements
- T 7.4.6 Microstrip Lines and Passive SMD Circuits
- T 7.6.1 Wire Antennas and Apertures



Christian Hülsmeier is considered to be one of the forefathers of modern radars. His telembiloscope was able to detect metallic objects from far away.

Multimedia Radar Trainer

Features

- Active radar for classroom and lab operation.
- All measurements are performed in real time. No subsampling or substitution techniques!
- Real target detection. Targets are placed at random locations in the laboratory. No specific "target table" is required.
- Latest technologies: SMD, Bluetooth etc
- Modern multimedia documentation
- Low power, secure operation
- Pulse radar with variable duty cycle
- Test points for external measurements
- Powerful radar image processor
- Display unit: A-Scope, PPI
- PPI mode: Full and sector scan
- Digital interactive monitor
- Classic radar with differential scan mode
- Tracking mode with lost/found indicator
- Adjustable markers (VRM)
- Adjustable anti-clutter gain control (STC)
- Adjustable decision threshold
- Switchable echo signal filter
- Experiments on binary target extractor
- Proximity detector
- Object vigilance
- Experiments on background noise
- Analysis of false alarm rate
- Experimental simulation of artificial interference sources
- Superior representation and analysis tools
- Concise, complete course with multimedia experiment guidance based on the COM3LAB philosophy
- Comprehensive! Includes all relevant experiments on radar technology.
- No additional add-on courses are required!
- Space-saving storage

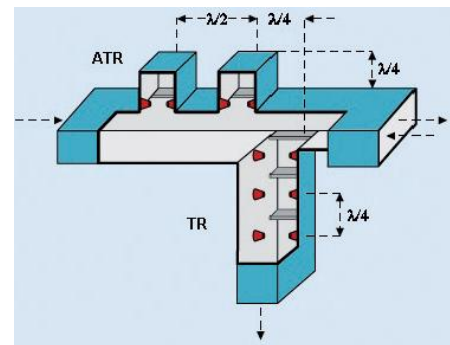

Classical circuit components like duplexers with gas-discharge tubes (nullodes, red) are also explained.



Stealth design. An important subject in military aeronautics.



The radar operating frequency defines its range. Long-range radars operate at low frequencies and require large aerials.

Multimedia Radar Trainer

Measurements

Transmitted and echo signals

With the help of an external Sensor-CASSY, transmitted and echo signals can be directly represented in the time domain. This is new in experimental radar technology!

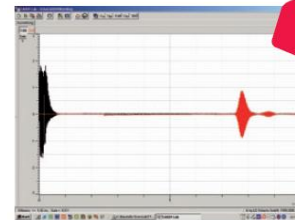

New

A-Scope

The A-Scope is used for measuring distances to radar targets in a defined direction. It consists of a radar display unit with Cartesian representation, in which the horizontal axis shows the distance between the radar and the target object.

The A-scope of the radar trainer is entirely digital and interactive. A large number of analysis and measuring tools is available.

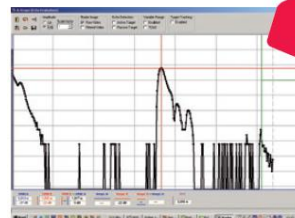

New

Verification of the radar equation

After verifying the far field condition, the central equation of radar technology ($1/r^4$) is quantitatively proved in the experiment. An ambitious experiment that demands a precise measurement technique with a high dynamic range.



New

Measurement of pulse train frequency

With the Sensor-CASSY, the pulse train frequency is directly measured and analyzed at the gate generator.

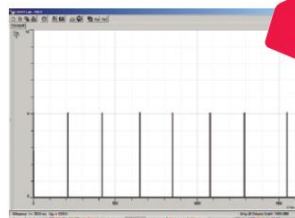

New

T 7.5.1 Ultrasonic Radar



Experiment setup for the ultrasonic radar with corner reflector and transponder. Important experiments are the measurements of radar cross sections (RCS) for different reflector types.

Topics

1. Introduction

- Course operation
- Course content
- History
- Theoretical fundamentals
- Technical implementation

2. Experiment Setup

- Equipment for the
- Ultrasonic radar
- Ultrasonic radar
- Radar targets
- First steps
- System control and signal

3. Radar Physics

- Emitted pulses in the time domain
- Echo pulses in the time domain
- Echo representation in the A-Scope

- Measurement of pulse train frequency
- RCS of a quadratic reflector
- RCS of a corner reflector
- RCS of a spherical reflector
- Comparing scatterers
- RCS values
- Verification of the radar equation
- Measuring the average pulse power
- Range resolution
- Visibility
- Stealth
- Artificial disturbers

4. Target Positioning

- Radar displays
- False alarm rate
- Classical radar
- Digital radar

- Sector scanning
- Representing clutter
- Determining range
- Background noise

5. Secondary Radar

- Radar marker
- Radar beacon
- Transponder
- Collision detection
- Interferences in SSR

6. Target Tracking

- The principle of target tracking
- Experiment setup
- Interpretation

T 7.5.1 Ultrasonic Radar

Detecting Targets & Measuring Distances

The sonar base and sonar pulse generator constitute the ground station for a monostatic, ultrasonic pulse radar. In monostatic systems, the transmitter and receiver are combined in one station and make use of the same aerial. The measurement data is transferred to the PC and radar control via wireless Bluetooth technology. The PC takes care of the radar image processing as well, generating the echo representation on the monitor in the well-known form of A-Scope and PPI. There are test sockets available for measurements at the radar duplexer, e.g. for representing echo signals, emitted pulses, echo delay measurements etc. An external CASSY-Interface can be connected to the test sockets.

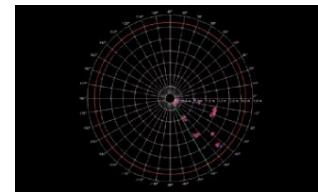

Close-range radar

The ultrasonic radar is a high-resolution surveillance system for close range that allows target objects to be located at a distance of up to approx. 10 m with a precision in the cm-range.

EQUIPMENT LIST T 7.5.1

Ultrasonic Radar

Quantity	Cat. No.	Description
1	737 60	COM3LAB-Course: Radar Technology I The 737 60 package content includes:
1		Sonar base rotating panel with Bluetooth data transfer, including power supply, battery charger, cable, accessories and control software, parabolic dish aerial
1		Sonar Pulse Generator, incl. Bluetooth data transfer,
1		Set of Passive Targets
2		Transponder
1		Tripod
1		Plug in Power Supply 230 V AC
1		Universal Recharger
8		NiMH Mignon cell, AA 1.2 V 1800 mA
2		Storage Tray
5		Partition
		Accessories required
1	524 013S	Sensor-CASSY 2 Starter

An actual material list including accessories is available on request.

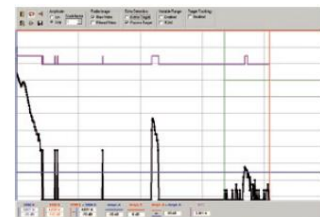
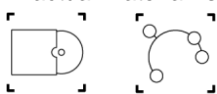

Radar displays

The analysis and representation of echo signals takes place on the PPI or A-Scope. Active and passive targets are studied (transponder).

- Binary Target Extractor (violet)
- STC (green)
- Distance Marker (red)
- Decision Threshold (blue)

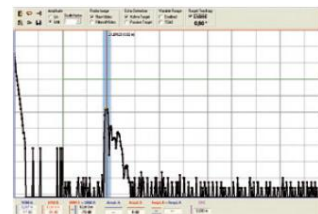

Target tracking

Inside the blue sector, the radar immediately tracks the target movement. Recognized targets are marked.

T 7.5.1 Ultrasonic Radar

More Experiments

Experiment on false alarm rate

The digital monitor is the most common display unit used for radar systems. It is combined with a computer, which is able to display additional information as well as the familiar target representation in PPI form. From the monitor the radar can be interactively controlled.

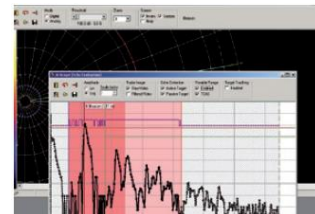

Collision avoidance (TCAS)

After crossing the green warning zone, the opponent target object has just penetrated the red security zone. A warning notice is triggered.

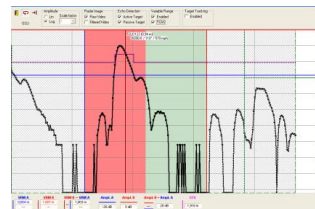

Ambiguities due to lab clutter

In small labs, wall reflections can produce ghost images that show false targets behind the walls.

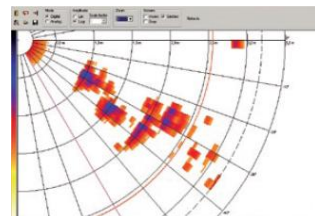

Experiment on secondary radar (SSR)

For the transponder, target identifications can be entered. In addition, a random data generator can produce flight data that is superimposed on the screen. The transponder also operates as a radar beacon or in IFF mode.



Ultrasonic Radar

TECHNICAL DATA

Principle	Monostatic ultrasonic pulse sonar
Radar type	Multiprocessor based incoherent radar
Operating frequency	Carrier frequency 40 kHz ADC sampling rate: 20 kHz
Range	> 10 m
Range Resolution	< 1 cm
Radar aerial	Parabolic dish, 400 mm, 29 dB
Aerial resolver	Angular resolution: $0.5^\circ/1^\circ/2^\circ$ Data transfer: Bluetooth
Transmitter	Pulse power: 120dB SPL
Receiver	Echo resolution: max 500 measuring points Quantisation of echoes 17 bit
Duplexer	PC-controlled
Gate generator	Duty cycle: 1 % Number of carrier oscillations, adjustable: $n = 1 \dots 32$
Logarithmic amplification	Dynamic > 100 dB
Display mode / display unit	Radar image processor with binary target extractor Display Unit A-Scope: Logarithmic 0...-100 dB Linear 100% ...0.001% PPI: Classic with decision threshold Digital: color-coded echo amplitude measurement PPI plot with offset representation and echo zoom PPI display: monochrome, color
Primary radar (PR)	Modes of operation: Tracking, scanning (sector scan, full scan) manual positioning
Secondary Radar (SSR)	Transponder with automatic switch-off delay (15 min.) Modes of operation: Radar beacon, friend/foe recognition (IFF) Editable transponder list with flight data simulator for altitude, course, speed Collision avoidance: TCAS with two-zone surveillance Target tracking
Instruments	Binary anti-clutter gain control (STC) with close/far range Discriminator. Fire control radar with optical and acoustic lost/found detector
System Platform	PC, Intel IV
Operating system	Windows XP or higher
Operating voltage	Sonar base: selectable plug-in power supply 230 V / 115 V 50 – 60 Hz
Displays / Analysis	Mobile marker: decision threshold, VRM, STC, distance, differential distance, amplitude, differential amplitude Position indication in m Amplitude indication lin in % or log in dB
Mechanical dimensions	Weight: approx. 5 kg 400 mm x 400 mm x 600 mm
Documentation	Interactive multimedia training software with extensive glossary Languages: german/english/french/spanish



COM3LAB Course
Radar Technology I



Ultrasonic Radar



Kilowatt and Kilovolt
Microwave powers in the kilowatt range are indispensable for commercial applications, but there is no place for them in the classroom. RF sources represent a serious danger for all performers and jeopardize operations. And what happens if the system gets out of control?

T 7.5.2 Doppler Radar

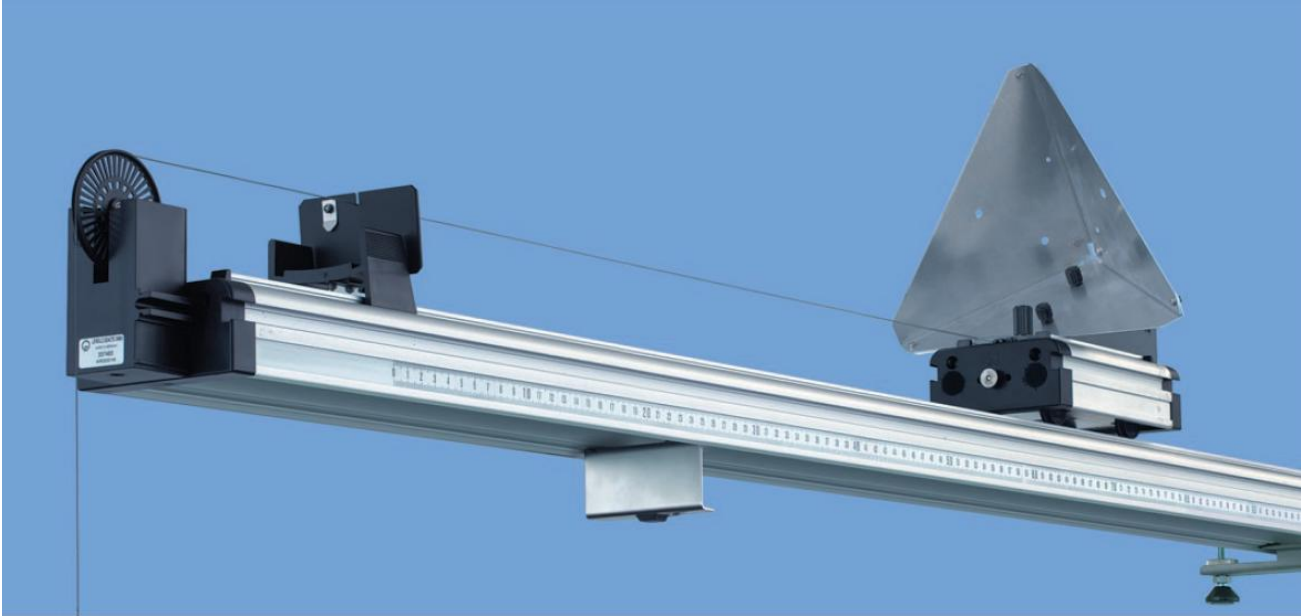

Experiment setup on a Doppler radar with track and trolley. The trolley is accelerated to typical laboratory speeds by means of a traction weight.

Topics

1 Introduction

- Course operation
- Course content

2 Doppler Effect

- Transmission links
- Situation in Radar
- Block diagrams
- Spectral components at the mixer
- Applications

3 CW-Doppler Radar

- Training system
- Properties of microwaves
- CASSY measurements
- Setting into operation

4 Moving Targets

- Equations of motion
- Determining the acceleration
- Speed measurement
- Series of experiments: Direct measurements

- Series of experiments: FFT measurements
- Stealth in motion
- Multi target detection
- Proximity detector with alarm triggering

5 MTI Simulator

- Characteristic curves of the MTI simulator
- Object vigilance

T 7.5.2 Doppler Radar

Speed & Detection of Moving Objects

The COM3LAB Course Radar Technology II operates with an X-band microwave source (Gunn oscillator). It investigates the fundamentals and applications of the Doppler effect by means of measurements in the time and frequency domain (FFT analysis of the Doppler spectrum in base band).

EQUIPMENT LIST T 7.5.2

Doppler-Radar

Quantity	Cat. No.	Description
1	737 65	COM3LAB-Course: Radar Technology II 737 65 package content includes:
1	737 01	Gunn Oscillator
1	737 21	Large Horn Antenna
1		Set of Passive Targets
1		Doppler Converter
1		MTI Simulator
2	562 791	Plug In Power Supply 230 V
2	648 07	Storage Tray
5	64808	Partition
		Accessories required:
1	337 462	Combination Light Barrier
1	337 463	Holder for Combination Light Barrier
1	337 464	Combination Spoke Wheel
2	68341	Holding Magnet
1	337 110	Trolley
1	337 130	Track 1.5 m
1	524 013S	Sensor-CASSY 2 Starter
1	524 074	Timer

An actual material list including accessories is available on request.

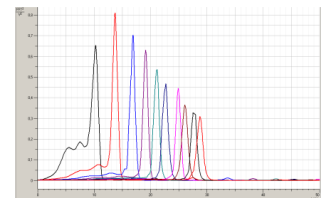
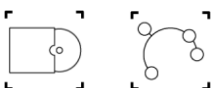

Representation of Doppler signals

FFT spectra for different vehicle speeds.

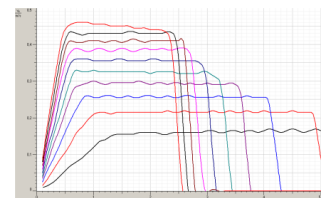

The velocity-time diagram

The trolley speed is measured with the motion transducer. The horizontal curve traces correspond to the stationary velocities after the acceleration phase and before reaching the track end. In the stationary velocities range, a discrete Doppler spectrum with individual lines is obtained (shown above).

T 7.5.2 Doppler Radar

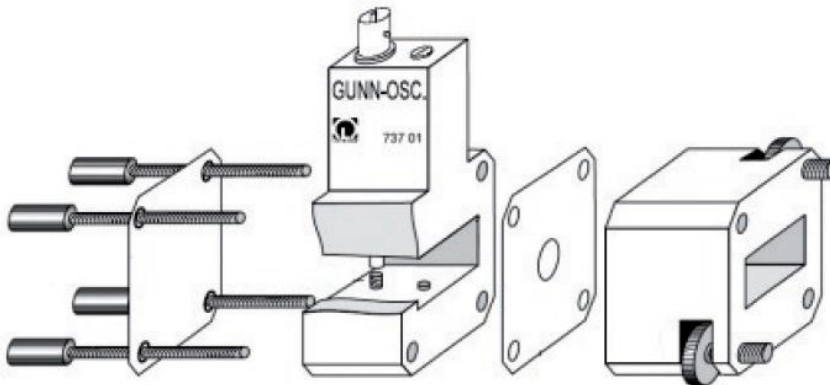

The microwave source
Schematic representation of the microwave source. The Gunn oscillator acts as a transceiver.

Doppler converter
Serves as a power supply for the Doppler module. The Doppler converter filters out the Doppler signal obtained by mixing the backscattered echo at the Doppler module.



Applications of Doppler radars
Speed measurement in road traffic is one of the routine tasks of Doppler radars.

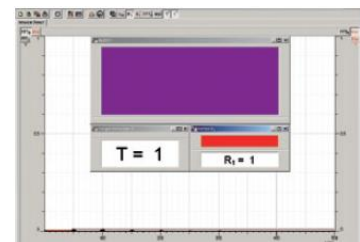

Proximity detector with alarm triggering
Target detector T is programmed as threshold circuit. It compares the Doppler spectrum amplitude with the configured threshold. When the echo signals exceed the threshold ($T = 1$), the relay circuit R is activated and the alarm is automatically triggered.

T 7.5.2 Doppler Radar

Equipment for 737 65
COM3LAB-Course
Radar Technology II



TECHNICAL DATA

Principle	Doppler radar module with self-mixing
Radar type	CW-Doppler
Operating frequency	Carrier frequency: 9.40 GHz
Range	2 m
Radar aerial	Horn
Transmitter	Power: +13 dBm
Doppler Converter	Doppler output: 0 Hz...500 Hz (approx. 0...25 km/h)
MTI	Radar cross section (RCS) of Doppler target:: 0.2 m ² Range off target frequency: 5 Hz ... 500 Hz Speed range: 8 cm/s ... 8 m/s
Display mode / display unit	Distance time diagram FFT spectrum Time domain display Proximity detector
System Platform	PC, Intel IV
Operating system	Windows XP or higher
Operating voltage	230 V / 115 V/50 – 60 Hz
Documentation	Interactive multimedia training software with extensive glossary Languages: german/english/french/spanish



MTI Simulator

The metallic membrane of the loudspeaker serves as a stationary Doppler target. The Doppler target is controlled through the control unit. With the MTI simulator, movements can be simulated and analyzed while the target stays at rest.

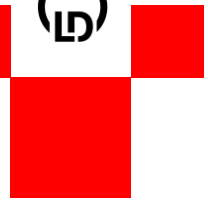

T 7.6 Antenna Technology



Antenna Laboratories

Equipment Sets

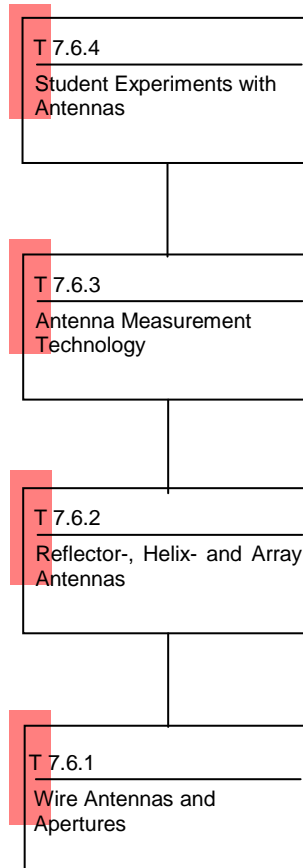

Directional diagrams at microwave frequencies

At 9.40 GHz, wavelength in free space is $\lambda_0 = 32$ mm. Due to short wavelengths, the dimensions for antennas lie in the cm range and even the space needed to perform measurements amounts to only about two meters. Conventional training systems only allow to measure antennas in the near field for reasons of laboratory space. Our training system gives access even to far field measurements. The experiments treat all important antenna types, such as: dipole, Yagis, parabola, helical, array and aperture antennas. Absorbers shield-off the measuring area. False measurements due to interfering reflections, a known phenomena for conventional antenna training systems that is particularly disturbing for low gain antennas, can be effectively reduced. Thus reproducible antenna measurements can even be obtained in the confinement of laboratory rooms. The recording and evaluation of polar diagrams is done in a time-efficient manner with the help of a computer-controlled rotating platform. This results in unequalled opportunities for presentation and recording. Sensitive receivers permit transmit power to be reduced to about 1 % of conventional values (10 mW).

Antenna Laboratories

General Notes

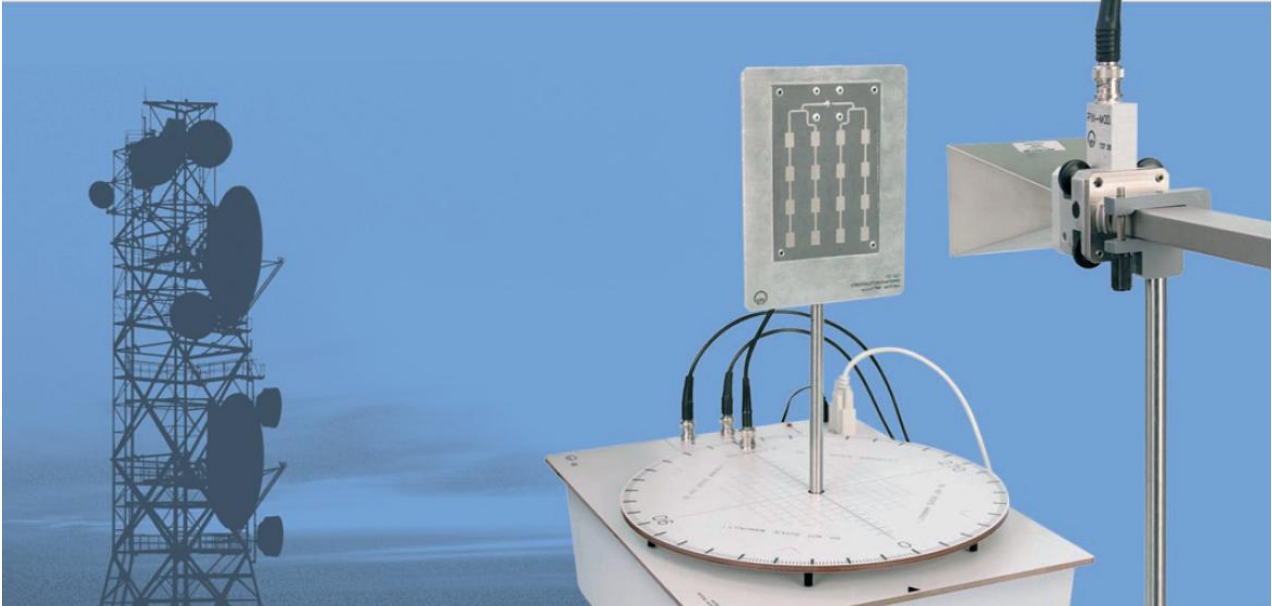

The T 7.6 Antenna training system operates with a computer-controlled rotating platform and the proven CASSY Lab software. The experiment setup is used for the measurement of polar diagrams. In this example a microstrip antenna is tested.

- Modular antenna sets
- Computer controlled rotating platform
- Near and far field calculator
- Small dimensions appropriate for laboratories
- Suppression of reflections with absorbers
- Reproducible results
- Best fit plot between measurements and theory
- 3D-Plotter for directional diagrams



T 7.6.1 Wire Antennas and Apertures

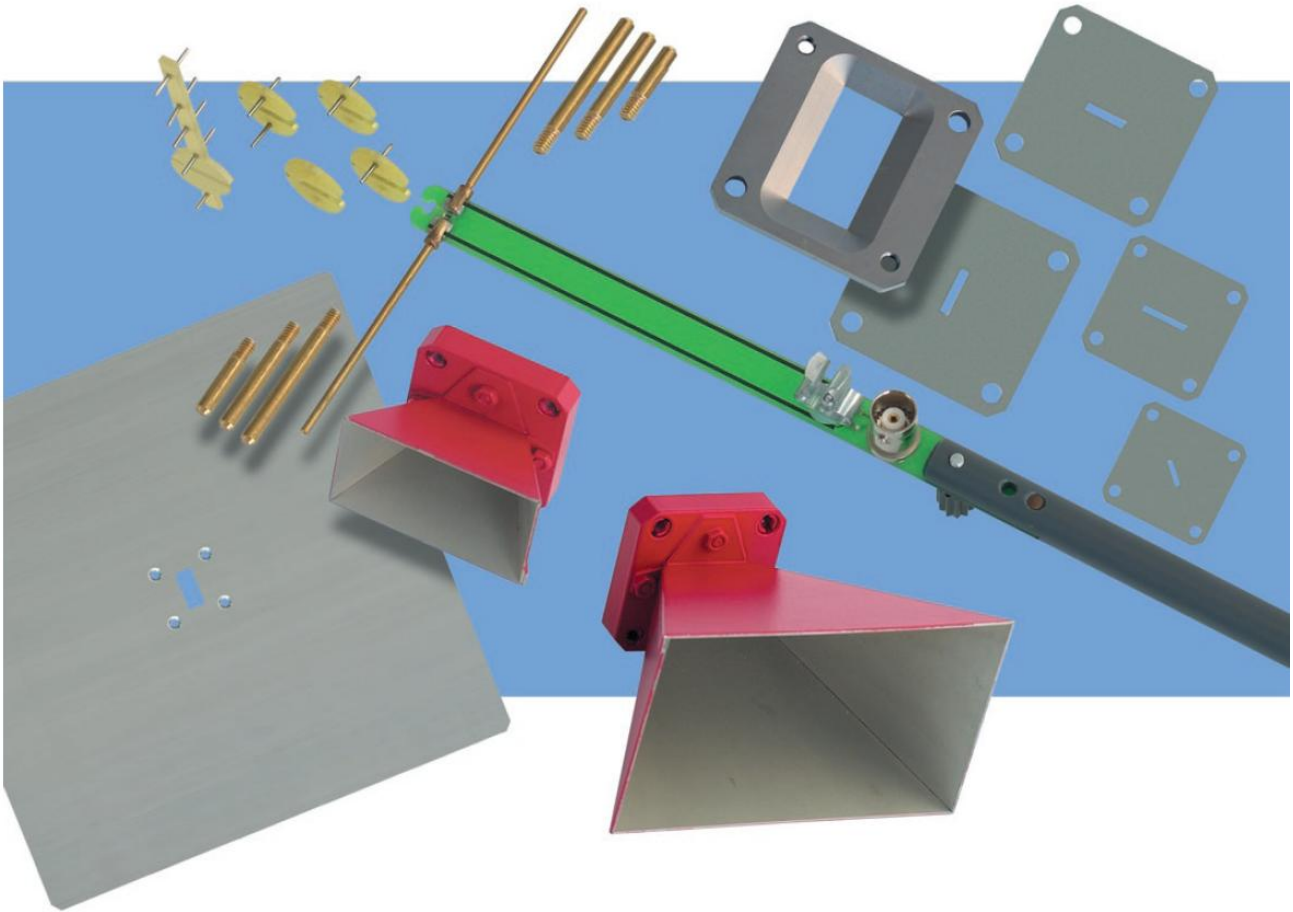

Topics (selection)

- Dipole antennas, variation of antenna length
- Yagi antennas, the influence of reflectors and directors
- Waveguides and horn antennas
- Cross talk between cross polarized channels
- Polarization attenuation

T 7.6.1 Wire Antennas and Apertures

Fundamental Antennas

This basic equipment set is part of the complete antenna lab T 7.6.2. It introduces into the handling of the antenna measurement station. Topics are the radiation properties of well known standard antennas. The antennas included in T 7.6.1 are single radiator systems in wire and aperture technology, e.g. dipoles, Yagis and horns.

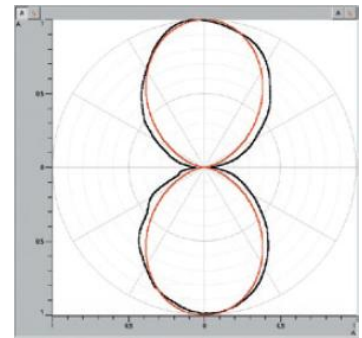

Dipole

Horizontal directional diagram of a $\lambda/2$ dipole in polar coordinates, linear presentation. Short dipoles exhibit practically no directional effect. They are therefore particularly vulnerable to reflections. Strongly bundled antennas, e.g. Yagis, are not sensitive in this respect.

EQUIPMENT LIST T 7.6.1

Wire Antennas and Apertures

Quantity	Cat. No.	Description
1	737 01	Gunn Oscillator
1	737 03	Coax Detector
1	737 035	Transition Waveguide Coax
1	737 05	PIN Modulator
1	737 06	Isolator
2	737 12	Waveguide 200 mm
1	737 135	3-Screw Transformer
1	737 20	Small Horn Antenna
2	737 21	Large Horn Antenna
1	737 390	Set of Microwave Absorbers
2	737 405	Rotating Antenna Platform
1	737 415	Wire Antenna Set
1	568 702	Book: Antenna Technology

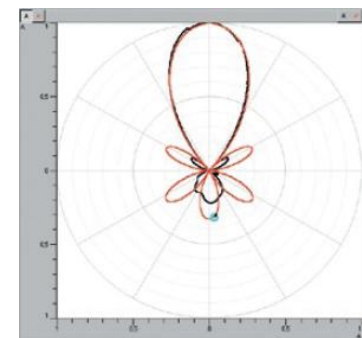

Yagi

Horizontal directional diagram pattern of a 5-element Yagi antenna in polar coordinates, linear presentation

An actual material list including accessories is available on request.

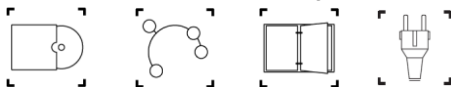

T 7.6.2 Reflector Helix- and Array Antennas



Topics (continued)

- Influence of reflections
- Circular polarizing antennas
- Helical antenna gain measurement
- Determining polarization attenuation
- Co-polarization and cross-polarization
- Parabolic reflector antennas
- Linear and planar array antennas
- Scanning with phase arrays
- Determining the scan angle
- Secondary lobes
- Fan lobes and pencil beam

T 7.6.2 Reflector- Helix- and Array Antennas

Complete Antenna Lab

This is the complete LD Antenna lab. It starts with the basics from *T 7.6.1 Wire Antennas and Apertures* and then leads to the subject of array antennas in linear and planar configuration. Beyond this, antenna systems with reflectors will be investigated. Helical antennas are used to carry out experiments for circular polarization. This equipment set contains an appropriate selection of practice models from an incomprehensible variety of all existing antenna shapes. Students who complete the experiments with LD antennas will also understand exotic models such as the butterfly, bat-wing, turnstile, etc..

EQUIPMENT LIST T 7.6.2

Wire Antennas and Apertures

Quantity	Cat. No.	Description
1	737 01	Gunn Oscillator
1	737 03	Coax Detector
1	737 033	Coax Transition male / male N, 50 Ohm
1	737 035	Transition Waveguide coax
1	737 05	PIN Modulator
1	737 06	Isolator
1	737 10	Moveable Short
2	737 12	Waveguide 200 mm
1	737 135	3-Screw Transformer
1	737 14	Waveguide Termination
1	737 16	Frequency Meter
1	737 197	E-Bend
1	737 20	Small Horn Antenna
1	737 27	Physics Microwave Accessories I
2	737 21	Large Horn Antenna
1	737 390	Set of Microwave Absorbers
1	737 405	Rotating Antenna Platform
1	737 415	Wire Antenna Set
1	737 424	Slot Antenna
1	737 427	Microstrip Antenna
1	737 440	Helical Antenna Kit
1	737 452	Dish Antenna
1	568 702	Book: Antenna Technology

An actual material list including accessories is available on request.

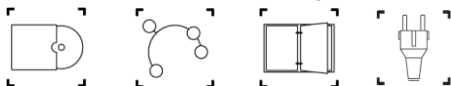

Sentry in flight
Airborne radar systems make it possible to realize effective mobile surveillance systems.

T 7.6.2 Reflector- Helix- and Array Antennas

More Experiments

Parabola

Directional diagram with Yagi excitation
Polar coordinates,
linear presentation

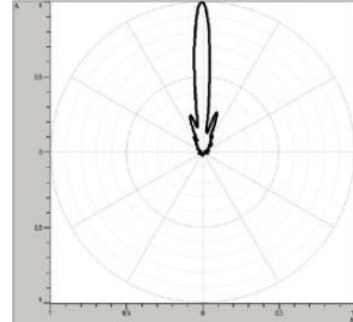

Parabola

Directional diagram with Yagi excitation
Polar coordinates,
logarithmic presentation in dB

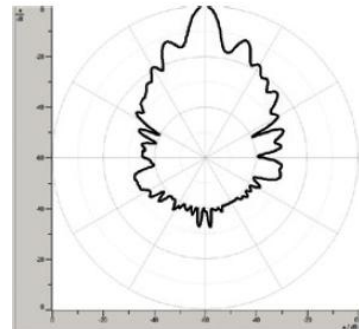

Arrays

Formation of secondary lobes
(grating lobes)
Directional diagram of the horizontal
slot antenna with covered center slots
Polar coordinates, linear presentation

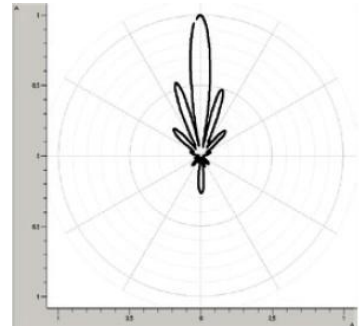

Electronic scanning

Phase array
Directional diagram of the horizontal
slot antenna at various frequencies
Scan angle: 16° for $\Delta f = 2$ GHz

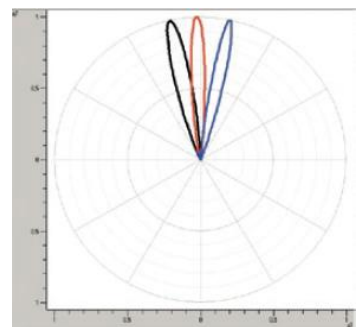

T 7.6.2 Reflector- Helix- and Array Antennas

Theory and Practice

Conventional antenna training often stops with the radiation diagram of dipoles and yagis. Not so the LD antenna labs. Shown are the directional diagrams taken from experiments, not from a computer animation.

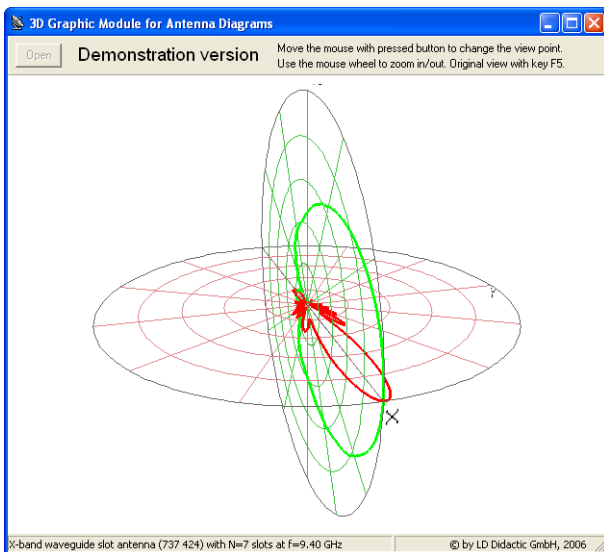

Even the equations for complex directional diagrams such as slot antennas with reflectors can be created with the formula editor. The result is shown as best fit approximation between theory and real measurements.

$$\left| \frac{A}{A_0} \right| = 2 \left| \sin \vartheta \begin{vmatrix} \sin\left(\frac{m\pi b}{\lambda_0} \cos \vartheta\right) \\ \sin\left(\frac{\pi b}{\lambda_0} \cos \vartheta\right) \end{vmatrix} \begin{vmatrix} \sin\left(\frac{n\pi a}{\lambda_0} \sin \varphi \sin \vartheta\right) \\ \sin\left(\frac{\pi a}{\lambda_0} \sin \varphi \sin \vartheta\right) \end{vmatrix} \cos\left(\frac{\pi}{2} - \frac{2\pi h}{\lambda_0} \cos \varphi\right) \right|$$

3D-Plots

Measurements of the horizontal and vertical directional diagrams can be combined to a 3D simulation.

The operating frequency of the antennas determines the lab's size. This is because laboratory area requirements expand rapidly with wavelength according to the equation below. And this means that for a system operating at 433 MHz about 10.000 times more measuring space will be required than would be the case for a 9400 MHz system!

$$\left(\frac{\lambda_{433}}{\lambda_{9400}} \right)^3 = \left(\frac{9400}{433} \right)^3 \approx 10.000$$

T 7.6.3 Antenna Measurement Technology

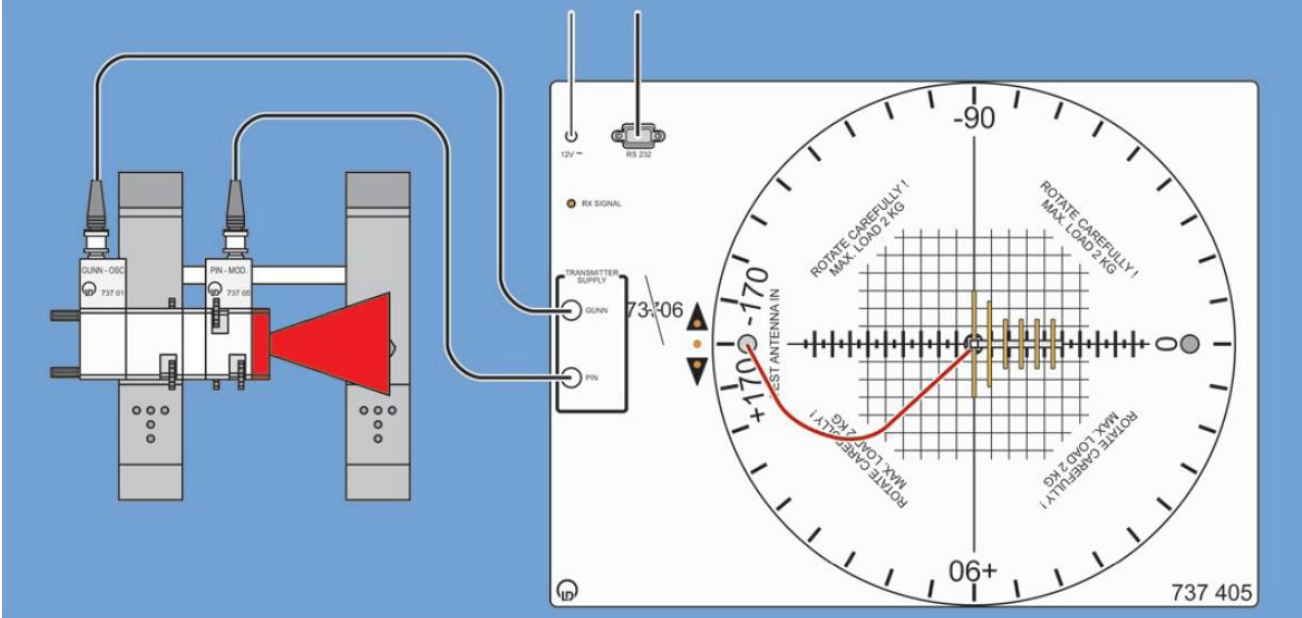

The setup drawings provide an impression of the compact size of the LD antenna measurement site. The professional lab instrumentation with real microwave absorbers, computer support and evaluation, guarantees experiment results that can be interpreted.

Topics

- Gain measurement with the triple antenna method
- Radiation characteristics of slot antennas
- Matching of single slots

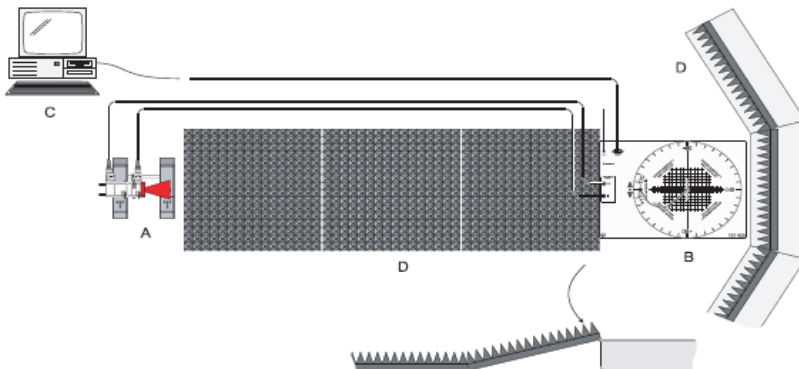

T 7.6.3 Antenna Measurement Technology

Reception power of three different antennas is measured for constant transmitter power, distance and wavelength. The results form a linear equation system from which the unknown gains G_1 , G_2 and G_3 can be calculated. The procedure is known as the triple antenna method. Necessary are a few waveguide components from T 7.4.3. The matching of single slot antennas is a classical waveguide experiment. The verification of Babinet's duality principle leads to the equivalence of directional diagrams between slots and dipoles.

EQUIPMENT LIST T 7.6.3

Antenna Measurement Technology

Quantity	Cat. No.	Description
1	737 01	Gunn Oscillator
1	737 03	Coax Detector
1	737 033	Coax Transition male male N, 50 Ohm
1	737 035	Transition Waveguide coax
1	737 05	PIN Modulator
1	737 06	Isolator
1	737 085	DC-Blocker
1	737 09	Variable Attenuator
1	737 12	Waveguide 200 mm
1	737 135	3-Screw Transformer
1	737 14	Waveguide Termination
1	737 18	Cross Directional Coupler
1	737 197	E-Bend
1	737 20	Small Horn Antenna
1	737 21	Large Horn Antenna
1	737 29	Waveguide Propagation Accessories
1	737 390	Set of Microwave Absorbers
1	737 405	Rotating Antenna Platform
1	737 424	Slot Antenna
1	737 427	Microstrip Antenna
1	737 440	Helical Antenna Kit
1	568 702	Book Antenna Technology

An actual material list including accessories is available on request.

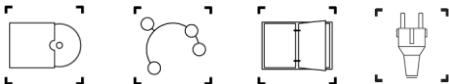

T 7.6.4 Student Experiments with Antennas

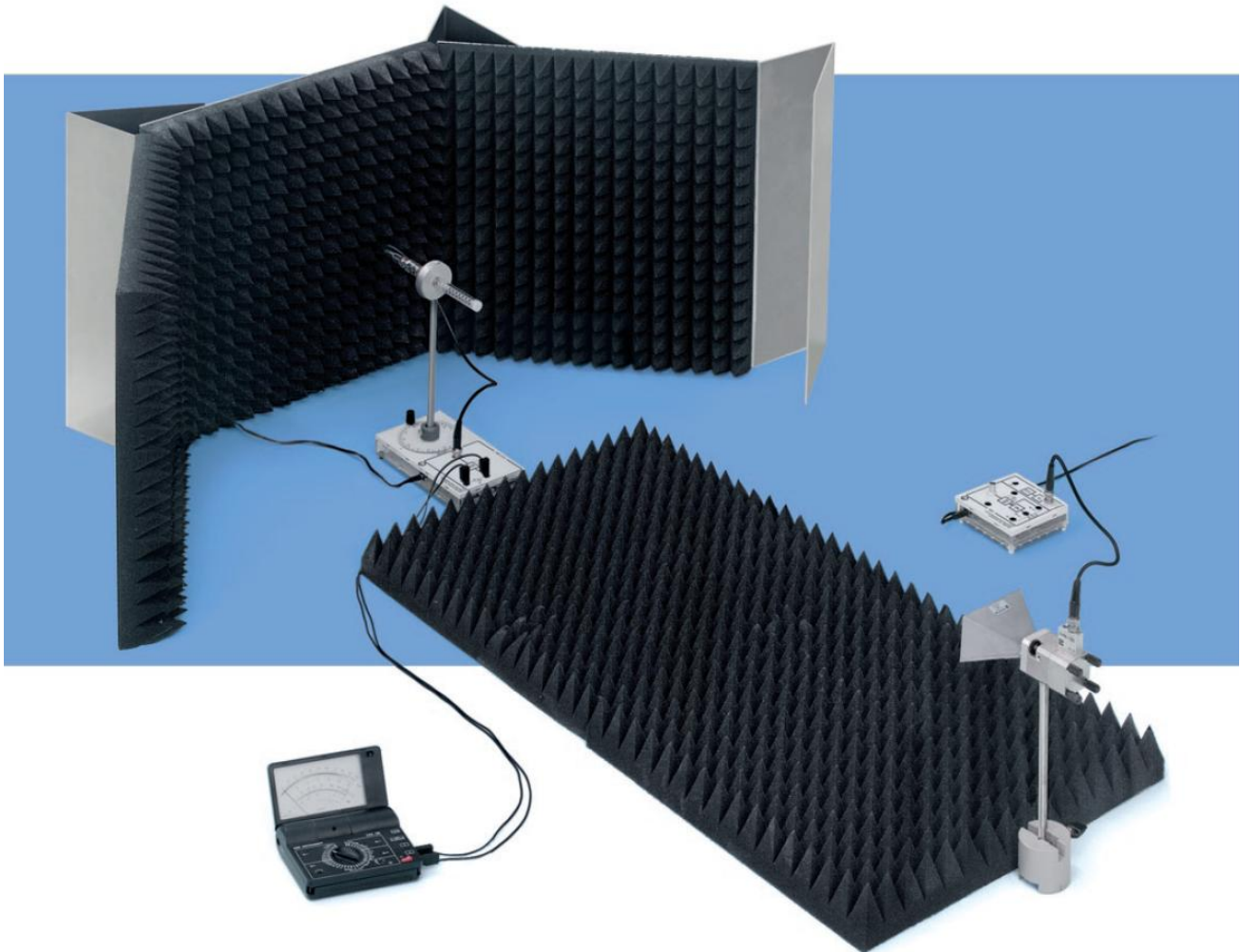

Our student system for antenna technology operates with a hand-operated rotating platform. The antennas measured here are of limited gain:

- Dipoles
- Yagis
- Helical antennas

Recording and evaluation are done in the classic manner – with pencil, paper and calculator.

Topics

- Principle characteristics of dipole and yagi antennas
- Polarization of wire antennas
- Disturbances caused by reflections
- Optimizing the lab room for free-space experiments

T 7.6.4 Student Experiments with Antennas

Experiments in free space

The experiment setup shows the microwave absorbers (from cat. no. 737 390) used to create an anechoic chamber. The use of absorbers is recommended for all antenna experiments as well as for free-space experiments with microwaves. They suppress both stationary reflections (e.g. reinforced concrete, furnishings) as well as moving reflections (e.g. wind in swinging blinds, fans, moving laboratory personnel). Here again, the small operating wavelength is helpful. This is because effective attenuation requires absorbers having a thickness d that roughly corresponds to the wavelength λ_0 .

$$d \sim \lambda_0$$

Adhering to this constraint would quickly become too expensive with increasing wavelengths.



Microwave absorber
Especially for low gain antennas (dipoles) anechoic chambers are indispensable

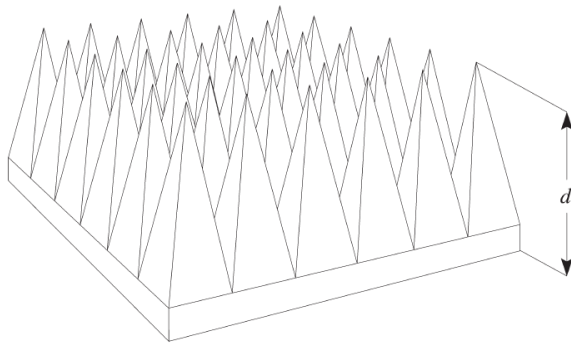

EQUIPMENT LIST T 7.6.4

Student Experiments with Antennas

Quantity	Cat. No.	Description
1	737 01	Gunn Oscillator
1	737 020	Gunn Power Supply with Amplifier
1	737 03	Coax Detector
1	737 21	Large Horn Antenna
1	737 390	Set of Microwave Absorbers
1	737 407	Antenna Stand with Amplifier
1	737 415	Set of Wire Antennas
1	737 440	Helical Antenna Kit
1	568 712	Book: Student Experiments in Antenna Technology

An actual material list including accessories is available on request.

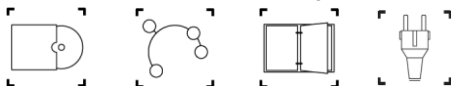

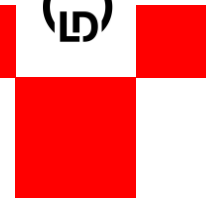

T 7.7 Electromagnetic Compatibility



T 7.7
Field bound EMC
Measurements

Electromagnetic compatibility

Electromagnetic compatibility (EMC) is a keyword ever since the beginnings of electrical engineering with a continuously growing impact on industry and daily life applications. EMC is a term of wide comprehension, which includes radio interference, system perturbations and exposure to electromagnetic radiation etc.. With the conquest of electronic appliances into ever more areas of application the requirements for proper EMI handling rise. Thus EMI is found today in all fields of electronics from communications and automation to automotive technology. Even the environmental pollution by electro smog is a matter of public concern. The application of international standards has shifted the EMI discussion into the focus of vocational training. This training system mainly investigates field bound EMC measurements. Demonstrative experiments are carried out on the following areas: undesired emissions, electromagnetic interference (EMI), shielding, grounding etc. Experiments give reproducible results for quantitative evaluation. A small power RF generator (10 mW) operating on the ISM frequency 433 MHz is used for the excitation of the test field. Thus a license for the operation of the training system is not required.

T 7.7.1 Field-bound EMC Measurements

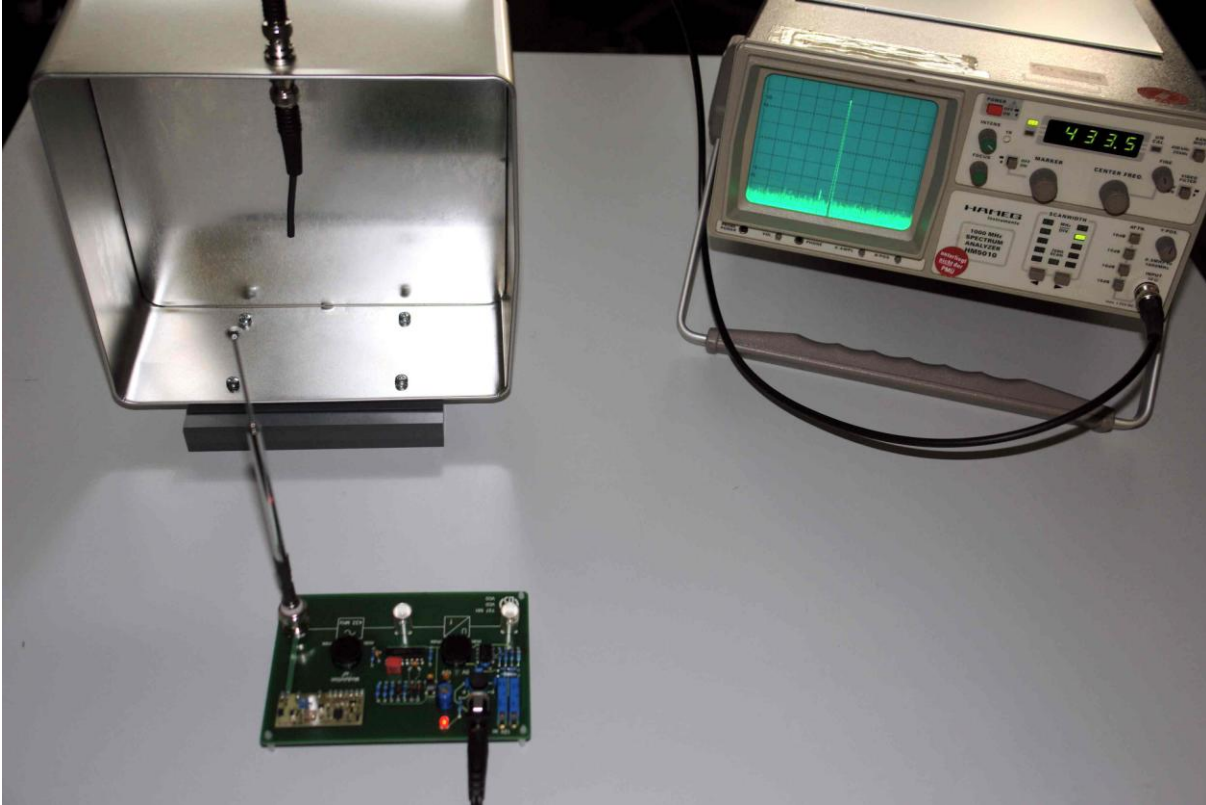

The LD test chamber can be closed by covers of different material. The small power RF generator requires no admission. The EMC trainer from LD Didactic gives hands on skills for practical experiences in the installation of electrical appliances.

- Small, no need for space consuming test chambers
- License free operation
- Comprehensive course for apprentices and students

Topics

- Calibration of the test chamber
- Shielding by a metal plate
- Shielding by a closed enclosure
- Radiation from an open enclosure
- Interference of a non grounded closed test chamber
- Interference of a grounded closed test chamber
- Comparison of different test probes $\lambda/4$ and $\lambda/8$
- Shielding by metal foils
- Suppressing surge with ferrite chokes

T 7.7.1 Field bound EMC Measurements

The EMC trainer contains passive and active components for the generation of electromagnetic test fields as well as screening material and cables. Measurement equipment is not included. For evaluation a spectrum analyzer with frequency range up to 1000 MHz is recommendable.



Components of the EMC trainer

- Test chamber with stand
- Cover for test chamber
- Dielectric plate
- Metal plate
- UHF test transmitter
- Cables
- RF cable with dc blocker
- Passive E-field probes
- BNC termination 50 Ω
- BNC T connector
- Plug in power supply
- Aluminum foil
- Ferrite choke
- Telescope antenna

EQUIPMENT LIST T 7.7.1

Field-bound EMC Measurements

Quantity	Cat. No.	Description
1	737 30	EMC Trainer
1	568 74EN	Book: Field bound EMC Measurements

An actual material list including accessories is available on request.

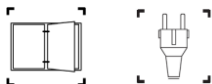

The UHF-generator in SMD / hybrid technology serves as the source for the RF-field.



Accessory Equipment Keywords



Lab Instrumentation

Cable Carts and Experimental Frames



Rollable experimental frames and setups are ideal in temporarily experiments and demonstrations. Cable carts keep the experimentation cables nearby during lab work.

Supply devices in industrial standard

The modular 19" system offers many options for integration of power supply into the laboratory!



Integration is possible in:

- the channel module
- the desktop
- in the high-level desktop
- as fold away variant

On demand, supply devices are even electrically lowerable.

Accessory

Selection of Lab Equipment

On the following pages there is a selection of the accessory like frames, cables, plugs, power supplies, function generators, etc. Detailed information will be included in your individual offer.

Frames

When teaching by demonstration or for laboratory experiments, transportable or permanently installed, our various profile frames provide many options.



Frame selection:

- Angled frame
- Freestanding frame
- Frame for mounting on the table
- Frame for mounting above the supply channels



Bridging plugs for connections on training panels.

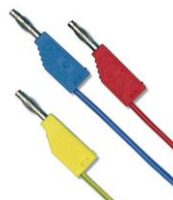
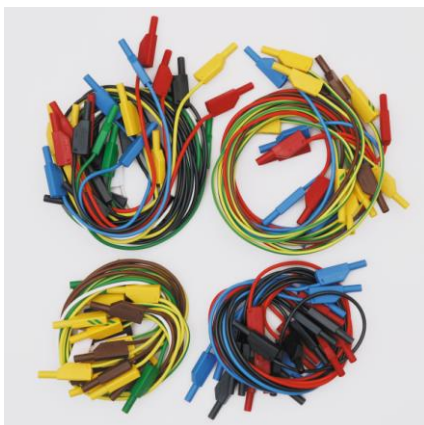

Experimentation cables and cable sets with standard or safety plugs.

Accessory

Selection of Lab Equipment

Power supply and function generators are indispensable in TPS experiment setups.

Stabilized Power Supply

Laboratory power supply with two separate and stabilized fixed voltages for vertical assemblies in panel frames or demonstration-experiment frame. Rated-voltage monitoring via two green LED.

Technical data

- Output voltage: ± 15 VDC via 4-mm sockets
- Maximum current: 3 A
- Fixed voltages: stabilized, short circuit proof
- Nominal voltage monitor: two green LED's
- Residual ripple: 0.3 mV
- Temperature range: 0-50°C
- Mains voltage: 230 V, 50/60 Hz
- Power consumption: 160 VA

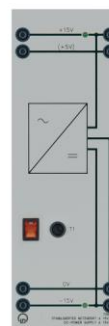

Function Generator

Microprocessor-controlled signal generator. Versatile in many experiments. Easy to handle. Best suited to the needs of panel experiment setups.

Technical data

- Functions: sine/triangular/square/DC
- Duty cycle: 10 %...90 %
- Frequency range: 1 Hz...200 kHz
- Output voltage: 0...20 V_{pp}
- DC offset: ± 10 V
- Display: 4-digit LC display for signal parameters and functions
- Attenuator: 0 dB, -20 dB, -40 dB
- Output: Impedance 50 Ohm
- Trigger output: TTL level
- Output: via 4-mm safety sockets
- Mains voltage: 230 V, 50/60 Hz



Equipment Sets

Complete Lists Including Accessories

T 7.1.1.1 Foundations of Local and Trunk Exchange Systems

Equipment Set

1	735 800	C3L Course: Foundations of Local & Trunk Exchange Systems
---	---------	---

Accessories

1		Personal Computer with Operating System
---	--	---

T 7.1.1.2 DECT-Telephones

Equipment Set

1	735 800	C3L Course: Foundations of Local & Trunk Exchange Systems
---	---------	---

1	735 805	COM3LAB Course: DECT-Telephones
---	---------	---------------------------------

Accessories

1		Personal Computer with Operating System
---	--	---

T 7.1.2.1 Fundamentals of ISDN Technology

Equipment Set

1	735 900	Fundamentals of ISDN Technology
---	---------	---------------------------------

Accessories

1		Personal Computer with Operating System
---	--	---

T 7.1.2.2 Digitalization of the Voice Signal

Equipment Set

1	736 061	PAM Modulator
---	---------	---------------

1	736 071	PAM Demodulator
---	---------	-----------------

1	736 101	PCM Modulator
---	---------	---------------

1	736 111	PCM Demodulator
---	---------	-----------------

Accessories

1	726 09	Panel Frame T130, two level
---	--------	-----------------------------

1	726 86	Stabilized Power Supply +/- 15 V/3 A
---	--------	--------------------------------------

2	726 961	Function Generator 200 kHz, 230 V
---	---------	-----------------------------------

1	524 013S	Sensor-CASSY 2 - Starter
---	----------	--------------------------

2	501 461	Pair Cables, 100 cm, black
---	---------	----------------------------

3	501 511	Set of 10 Bridging Plugs, black
---	---------	---------------------------------

1	564 002	Book: Pulse Code Modulation T 7.2.2.1
---	---------	---------------------------------------

1		Personal Computer with Operating System
---	--	---

Equipment Sets

Complete Lists Including Accessories

T 7.2.1.2 **Fourier Analysis and Synthesis**

Equipment Set

1	736 031	Frequency Synthesizer
---	---------	-----------------------

Accessories

1	726 09	Panel Frame T130, two level
1	726 86	Stabilized Power Supply +/- 15 V/3 A
1	726 961	Function Generator 200 kHz, 230 V
1	524 013S	Sensor-CASSY 2 - Starter
2	501 511	Set of 10 Bridging Plugs, black
2	501 461	Pair Cables, 100 cm, black
1	564 472	Book: Fourier Analysis and Synthesis T 7.2.1.2
1		Personal Computer with Operating System

T 7.2.1.3 **Amplitude Modulation**

Equipment Set

1	736 201	CF-Transmitter 20 kHz
1	736 221	CF-Receiver 20 kHz

Accessories

1	726 09	Panel Frame T130, two level
1	726 86	Stabilized Power Supply +/- 15 V/3 A
1	726 961	Function Generator 200 kHz, 230 V
1	524 013S	Sensor-CASSY 2 - Starter
3	501 511	Set of 10 Bridging Plugs, black
2	501 461	Pair Cables, 100 cm, black
1	564 051	Book: Amplitude Modulation T 7.2.1.3
1		Personal Computer with Operating System

Equipment Sets

Complete Lists Including Accessories

T 7.2.1.4 Applied Amplitude Modulation

Equipment Set		
1	736 201	CF-Transmitter 20 kHz
1	736 211	CF-Transmitter 16 kHz
1	736 221	CF-Receiver 20 kHz
1	736 231	CF-Receiver 16 kHz
Accessories		
1	726 09	Panel Frame T130, two level
1	726 86	Stabilized Power Supply +/- 15 V/3 A
2	726 961	Function Generator 200 kHz, 230 V
1	524 013S	Sensor-CASSY 2 - Starter
4	501 511	Set of 10 Bridging Plugs, black
1	501 512	Set of 10 Bridging Plugs with Tap, black
4	501 461	Pair Cables, 100 cm, black
1	564 052	Book: Amplitude Modulation T 7.2.1.3
1	564 062	Book: Applied Amplitude Modulation T 7.2.1.4
1		Personal Computer with Operating System

Equipment Sets

Complete Lists Including Accessories

T 7.2.1.5 Frequency Modulation

Equipment Set		
1	736 27	FM/PM-Modulator
1	736 28	FM/PM-Demodulator
Accessories		
1	726 09	Panel Frame T130, two level
1	726 86	Stabilized Power Supply +/- 15 V/3 A
1	726 961	Function Generator 200 kHz, 230 V
1	524 013S	Sensor-CASSY 2 - Starter
2	501 511	Set of 10 Bridging Plugs, black
2	501 461	Pair Cables, 100 cm, black
1	564 072	Book: Frequency Modulation T 7.2.1.5
1		Personal Computer with Operating System

T 7.2.2.1 Pulse Code Modulation

Equipment Set		
1	736 061	PAM Modulator
1	736 071	PAM Demodulator
1	736 101	PCM Modulator
1	736 111	PCM Demodulator
Accessories		
1	726 09	Panel Frame T130, two level
1	726 86	Stabilized Power Supply +/- 15 V/3 A
2	726 961	Function Generator 200 kHz, 230 V
1	524 013S	Sensor-CASSY 2 - Starter
3	501 511	Set of 10 Bridging Plugs, black
1	501 512	Set of 10 Bridging Plugs with Tap, black
1	501 441	Pair of Cables 25 cm, black
2	501 461	Pair Cables, 100 cm, black
1	564 002	Book: Pulse Code Modulation T 7.2.2.1
1		Personal Computer with Operating System

Equipment Sets

Complete Lists Including Accessories

T 7.2.2.2 Pulse Time Modulation

Equipment Set		
1	736 081	PTM Modulator
1	736 091	PTM Demodulator
Accessories		
1	726 09	Panel Frame T130, two level
1	726 86	Stabilized Power Supply +/- 15 V/3 A
1	726 961	Function Generator 200 kHz, 230 V
1	524 013S	Sensor-CASSY 2 - Starter
2	501 511	Set of 10 Bridging Plugs, black
2	501 461	Pair Cables, 100 cm, black
1	564 012	Book: Pulse Time Modulation T 7.2.2.2
1		Personal Computer with Operating System

T 7.2.2.3 Delta Modulation

Equipment Set		
1	736 041	Delta Modulator
1	736 051	Delta Demodulator
Accessories		
1	726 09	Panel Frame T130, two level
1	726 86	Stabilized Power Supply +/- 15 V/3 A
1	726 961	Function Generator 200 kHz, 230 V
1	524 013S	Sensor-CASSY 2 - Starter
3	501 511	Set of 10 Bridging Plugs, black
1	501 461	Pair Cables, 100 cm, black
1	564 022	Book: Delta Modulation T 7.2.2.3
1		Personal Computer with Operating System

Equipment Sets

Complete Lists Including Accessories

T 7.2.2.4 Shift Keying and Modems

Equipment Set

1	700 74	COM3LAB Course: Modem Technology
---	--------	----------------------------------

Accessories

1	700 00USB	COM3LAB Master Unit
---	-----------	---------------------

1	700 00CBTEN	COM3LAB Software, english
---	-------------	---------------------------

1		Personal Computer with Operating System
---	--	---

Recommendations

1	736 481	Star Quad Cable
---	---------	-----------------

1	736 461	Set of Coaxial Lines
---	---------	----------------------

2	575 24	Screened Cable BNC / 4 mm
---	--------	---------------------------

2	501 02	BNC Cable, 1 m
---	--------	----------------

1	501 511	Set of 10 Bridging Plugs, black
---	---------	---------------------------------

T 7.2.2.5 COM3LAB - Multimedia: Transmission Technology

Equipment Set

1	700 73	COM3LAB Course: Digital Communication Technology
---	--------	--

1	700 74	COM3LAB Course: Modem Technology
---	--------	----------------------------------

1	700 75	COM3LAB Course: Telecommunication Lines
---	--------	---

Accessories

1	700 00USB	COM3LAB Master Unit
---	-----------	---------------------

1	700 00CBTEN	COM3LAB Software, english
---	-------------	---------------------------

1		Personal Computer with Operating System
---	--	---

Equipment Sets

Complete Lists Including Accessories

T 7.2.3 Noise on Transmission Channels

Equipment Set		
1	736 27	FM/PM Modulator
1	736 28	FM/PM Demodulator
1	736 061	PAM Modulator
1	736 071	PAM Demodulator
1	736 081	PTM Modulator
1	736 091	PTM Demodulator
1	736 101	PCM Modulator
1	736 111	PCM Demodulator
1	736 201	CF Transmitter 20KHz
1	736 221	CF Receiver 20KHz
1	736 311	Noise Sources
Accessories		
1	726 09	Panel Frame T130, two level
1	726 86	Stabilized Power Supply +/- 15 V/3 A
1	726961	Function Generator 200 kHz, 230 V
1	524 013S	Sensor-CASSY 2 - Starter
1	501 441	Pair of Cables 25 cm, black
2	501 461	Pair Cables, 100 cm, black
3	501 511	Set of 10 Bridging Plugs, black
1	501 512	Set of 10 Bridging Plugs with Tap, black
1	564 002	Book: Pulse Code Modulation T 7.2.2.1
1	564 012	Book: Pulse Time Modulation T 7.2.2.2
1	564 052	Book: Amplitude Modulation T 7.2.1.3
1	564 072	Book: Frequency Modulation T 7.2.1.5
1	564 182	Book: Noise on Transmission Channels T 7.2.3
1		Personal Computer with Operating System
Measurement Instrument		
1	531 110	Multimeter LD analog 10

Equipment Sets

Complete Lists Including Accessories

T 7.2.4.2 Measurements on Four-Wire Lines

Equipment Set		
1	737 041	Lock-In Amplifier
1	736 481	Star Quad Cable
Accessories		
1	726 961	Function Generator 200 kHz, 230 V
1	524 013S	Sensor-CASSY 2 - Starter
1	501 511	Set of 10 Bridging Plugs, black
1	568 542	Book: Measurements on Four-Wire Lines T 7.2.4.2

T 7.2.4.3 Measurements on Coaxial Lines

Equipment Set		
1	736 471	Pulse Generator
1	736 461	Set of Coaxial Lines
1	736 463	Coaxial Adapter
Accessories		
1	562 791	Plug-In Power Supply 12 V AC
1	575 294	Digital Storage Oscilloscope 507
2	575 231	Probe 100 MHz 1:1/10:1
2	501 02	BNC Cable, 1 m
1	568 532	Book: Measurements on Coaxial Lines T 7.2.4.3

T 7.2.4.4 COM3LAB - Multimedia: Transmission Lines

Equipment Set		
1	700 75	COM3LAB Course: Telecommunication Lines
Accessories		
1	700 00USB	COM3LAB Master Unit
1	700 00CBTEN	COM3LAB Software, english
1		Personal Computer with Operating System

Equipment Sets

Complete Lists Including Accessories

T 7.2.6.1 Experiments with PMMA Fibers

Equipment Set		
1	736 411	LWL Transmitter
1	736 412	LWL Receiver
1	736 415	Fiber-Micropositioner
1	736 416	Mode Scrambler
1	736 421	Set of Fiber Optic Waveguides and Accessories
1	736 429	LWL-Microscope
1	524 0512	Optical Power Sensor S
Accessories		
2	562 791	Plug-In Power Supply 12 V AC
1	524 013S	Sensor-CASSY 2 - Starter
1	500 604	Safety Connection Lead 10 cm black
1	500 641	Safety Connection Lead 100 cm red
1	500 642	Safety Connection Lead 100 cm blue
2	500 644	Safety Connection Lead 100 cm black
1	564 482	Book: Experiments with PMMA Fibers T 7.2.6.1

Equipment Sets

Complete Lists Including Accessories

T 7.2.6.2 Data Transmission with Optical Fibers

Equipment Set		
1	736 061	PAM Modulator
1	736 071	PAM Demodulator
1	736 101	PCM Modulator
1	736 111	PCM Demodulator
1	736 401	LWL Adapter
1	736 415	Fiber-Micropositioner
1	736 416	Mode Scrambler
1	736 425	Set of FSMA-Optical Fibers
1	524 0512	Optical Power Sensor S
Accessories		
1	726 09	Panel Frame T130, two level
1	726 86	Stabilized Power Supply +/- 15 V/3 A
2	726 961	Function Generator 200 kHz, 230 V
1	524 013S	Sensor-CASSY 2 - Starter
4	501 511	Set of 10 Bridging Plugs, black
1	500 414	Connecting Lead 25 cm black
1	501 512	Set of 10 Bridging Plugs with Tap, black
1	501 441	Pair of Cables 25 cm, black
2	501 461	Pair of Cables, 100 cm, black
1	564 002	Book: Pulse Code Modulation T 7.2.2.1
1	564 492	Book: Data Transmission with Optical Fibers T 7.2.6.2
1		Personal Computer with Operating System
Recommendation		
1	736 429	Fiber Optic Microscope

T 7.3 COM3LAB-Multimedia: Transmitting & Receiving Technology

Equipment Set		
1	700 71	COM3LAB Course: Transmitter Technology
1	700 72	COM3LAB Course: Receiver Technology
1	700 81	COM3LAB Course: Operational Amplifiers
Accessories		
1	700 00USB	COM3LAB Master Unit
1	700 00CBTEN	COM3LAB Software, english
1		Personal Computer with Operating System

Equipment Sets

Complete Lists Including Accessories

T 7.4.1 Microwaves in Free Space – Physical Principles

Equipment Set		
1	737 01	Gunn Oscillator
1	737 05	PIN Modulator
1	737 06	Isolator
1	737 21	Large Horn Antenna
1	737 27	Physics Microwave Accessories I
1	737 35	E-Field Probe
1	737 021	Gunn Power Supply with SWR Meter
1	524 013S	Sensor-CASSY 2 - Starter
1	568 722	Book: Microwaves in Free Space – Physical Principles T 7.4.1
Accessories		
3	301 21	Stand Base MF
1	301 26	Stand Rod, 25 cm
1	301 27	Stand Rod, 50 cm
1	311 77	Steel Tape Measure, L= 2 m/78 inch
2	501 091	BNC-T-Adapter
3	501 022	BNC Cable, L = 2 m
2	575 24	Screened Cable BNC / 4 mm
2	64807	Storage Tray S24-FN
6	648 08	Partition ZW 24
1		Personal Computer with Operating System

T 7.4.2 Free Space- and Waveguide Modes

Equipment Set		
1	737 01	Gunn Oscillator
1	737 05	PIN Modulator
1	737 06	Isolator
1	737 21	Large Horn Antenna
1	737 35	E-Field Probe
1	737 021	Gunn Power Supply with SWR Meter
1	737 075	Parallel Plate Line with Measuring Carriage
1	524 013S	Sensor-CASSY 2 - Starter
1	568 662	Book: Free Space- and Waveguide Modes T 7.4.2
Accessories		
2	737 15	Support for Waveguide Components
2	301 21	Stand Base MF
1	301 26	Stand Rod, 25 cm
4	501 022	BNC Cable, L = 2 m
2	575 24	Screened Cable BNC / 4 mm
2	648 07	Storage Tray S24-FN
6	648 08	Partition ZW 24
1		Personal Computer with Operating System

Equipment Sets

Complete Lists Including Accessories

T 7.4.3 Waveguide Technology

Equipment Set		
1	737 01	Gunn Oscillator
1	737 03	Coax Detector
1	737 05	PIN Modulator
1	737 06	Isolator
1	737 09	Variable Attenuator
1	737 10	Moveable Short
1	737 12	Waveguide 200 mm
2	737 14	Waveguide Termination
1	737 18	Cross Directional Coupler
1	737 29	Waveguide Propagation Accessories
1	737 021	Gunn Power Supply with SWR Meter
1	737 035	Transition Waveguide / Coax
1	737 095	Fixed Attenuator
1	737 111	Slotted Measuring Line
1	737 135	3-Screw Transformer
1	737 399	Set of 10 Thumb Screws M4
1	524 013S	Sensor-CASSY 2 - Starter
1	568 732	Book: Waveguide Technology T 7.4.3
Accessories		
2	737 15	Support for Waveguide Components
2	301 21	Stand Base MF
4	501 022	BNC Cable, L = 2 m
2	575 24	Screened Cable BNC / 4 mm
2	648 07	Storage Tray S24-FN
6	648 08	Partition ZW 24
1		Personal Computer with Operating System
2	737 15	Support for Waveguide Components
Recommendation		
1	737 13	Slide Screw Transformer
1	737 35	E-Field Probe

Equipment Sets

Complete Lists Including Accessories

T 7.4.4 Ferrite Components, Power Dividers and Active Elements

Equipment Set		
1	737 01	Gunn Oscillator
1	737 03	Coax Detector
1	737 05	PIN Modulator
1	737 06	Isolator
1	737 09	Variable Attenuator
1	73712	Waveguide 200 mm
3	737 14	Waveguide Termination
1	737 17	Phase Shifter
1	737 18	Cross Directional Coupler
1	737 29	Waveguide Propagation Accessories
1	737 021	Gunn Power Supply with SWR Meter
1	737 035	Transition Waveguide / Coax
1	737 065	Circulator
1	737 111	Slotted Measuring Line
1	737 195	Magic-T
1	524 013S	Sensor-CASSY 2 - Starter
1	568 752	Book: Ferrite Comp., Power Dividers and Active Elements T 7.4.4
Accessories		
2	737 15	Support for Waveguide Components
2	301 21	Stand Base MF
2	575 24	Screened Cable BNC / 4 mm
4	501 022	BNC Cable, L = 2 m
2	648 07	Storage Tray S24-FN
6	648 08	Partition ZW 24
1		Personal Computer with Operating System
Recommendations		
1	737 13	Slide Screw Transformer
1	737 35	E-Field Probe

Equipment Sets

Complete Lists Including Accessories

T 7.4.5 Circuits with Waveguide Components

Equipment Set		
2	737 01	Gunn Oscillator
1	737 03	Coax Detector
1	737 05	PIN Modulator
1	737 06	Isolator
1	737 08	Waveguide Detector
1	737 09	Variable Attenuator
1	737 10	Moveable Short
1	737 12	Waveguide 200 mm
1	737 13	Slide Screw Transformer
1	737 14	Waveguide Termination
1	737 16	Frequency Meter
1	737 29	Waveguide Propagation Accessories
1	737 015	Dielectric Tuning Unit
1	737 021	Gunn Power Supply with SWR Meter
1	737 035	Transition Waveguide / Coax
1	737 111	Slotted Measuring Line
1	524 013S	Sensor-CASSY 2 - Starter
1	568 692	Book: Circuits with Waveguide Components T 7.4.6
Accessories		
2	737 15	Support for Waveguide Components
2	301 21	Stand Base MF
2	575 24	Screened Cable BNC / 4 mm
4	501 022	BNC Cable, L = 2 m
1	501 091	BNC-T-Adapter
1	726 961	Function Generator 200 kHz, 230 V
2	648 07	Storage Tray S24-FN
6	648 08	Partition ZW 24
1		Personal Computer with Operating System

T 7.4.6 Microstrip Lines and Passive SMD Circuits

Equipment Set		
1	737 51	COM3LAB Course: Microwave Technology I
Accessories		
1		Personal Computer with Operating System

Equipment Sets

Complete Lists Including Accessories

T 7.4.7 Active UHF Components

		Equipment Set
1	737 51	COM3LAB Course: Microwave Technology I
1	737 52	COM3LAB Course: Microwave Technology II
		Accessories
1		Personal Computer with Operating System

T 7.4.8 Microwave Radio Link

		Equipment Set
		<i>RF-Components</i>
1	737 01	Gunn Oscillator
1	737 05	PIN Modulator
1	737 08	Waveguide Detector
2	737 20	Small Horn Antenna
1	737 021	Gunn Power Supply with SWR Meter
1	737 135	3-Screw Transformer
2	737 452	Dish Antenna
1	524 013S	Sensor-CASSY 2 - Starter
1	568 692	Book: Circuits with Waveguide Components T 7.4.6
		<i>Modulation</i>
1	736 061	PAM Modulator
1	736 071	PAM Demodulator
1	736 101	PCM Modulator
1	736 111	PCM Demodulator
1	564 002	Book: Pulse Code Modulation T 7.2.2.1
		Accessories
2	575 24	Screened Cable BNC / 4 mm
3	501 022	BNC Cable, L = 2 m
1	501 46	Pair of Cables 100 cm, red/blue
1	501 461	Pair Cables, 100 cm, black
3	501511	Set of 10 Bridging Plugs, black
1	726 86	Stabilized power supply +/- 15 V/3 A
2	726 961	Function Generator 200 kHz, 230 V
1	726 09	Panel frame T130, two level
1	648 07	Storage Tray S24-FN
3	648 08	Partition ZW 24
1		Personal Computer with Operating System

Equipment Sets

Complete Lists Including Accessories

T 7.4.9 Student Experiments with Microwaves

Equipment Set		
1	737 01	Gunn Oscillator
1	737 21	Large Horn Antenna
1	737 35	E-Field Probe
1	737 27	Physics Microwave Accessories I
1	737 020	Gunn Power Supply with Amplifier
1	737 275	Physics Microwave Accessories II
1	599 312	Book: Experiments with Microwaves
Accessories		
1	737 15	Support for Waveguide Components
1	311 77	Steel Tape Measure, L= 2 m/78 inch
4	300 11	Stand Base
2	501 022	BNC Cable, L = 2 m
1	501 46	Pair of Cables 100 cm, red/
1	501 461	Pair Cables, 100 cm, black
1	531 57	Multimeter METRAport 3A
1	648 07	Storage Tray S24-FN
3	648 08	Partition ZW 24

Equipment Sets

Complete Lists Including Accessories

T 7.5.1 Ultrasonic Radar

		Equipment Set
1	737 60	COM3LAB: Radar Technology I
		Accessories
1	501 02	BNC Cable, 1 m
1	501 46	Pair of Cables 100 cm, red/blue
2	500 444	Connecting Lead 100 cm black
1	524 013S	Sensor-CASSY 2 - Starter
1	700 00CBTEN	COM3LAB Software english
1		Personal Computer with Operating System

T 7.5.2 Doppler Radar

		Equipment Set
1	737 65	COM3LAB Course: Radar Technology II
1	700 00CBTEN	COM3LAB Software english
		Accessories
1	726 25	Panel Frame VT150, three level
1	524 013S	Sensor-CASSY 2 - Starter
1	524 032	Motion Transducer Box
1	337 462	Combination Light Barrier
1	337 463	Holder for Combination Light Barrier
2	337 464	Combination Spoke Wheel
1	683 41	Holding Magnet
1	337 110	Trolley
1	337 116	End Buffers, Pair
1	337 130	Track 1,5 m
4	73715	Support for Waveguide Components
5	301 01	Leybold Multiclamp
2	301 21	Stand Base MF
2	301 26	Stand Rod, 25 cm
1	30127	Stand Rod, 50 cm
1	309 48ET2	Fishing Line
1	311 77	Steel Tape Measure, L= 2 m/78 inch
2	315 410	Slotted Mass Hanger
11	315 418	Slotted Weight 10 g
1	501 022	BNC Cable, L = 2 m
1	501 16	Multi-Core Cable 6-polig, 1,5 m
1	501 46	Pair of Cables 100 cm, red/blue
1	500 404	Connecting Lead 10 cm black
2	500 441	Connecting Lead 100 cm red
4	500 442	Connecting Lead 100 cm blue
2	500 444	Connecting Lead 100 cm black
1		Personal Computer with Operating System
		Recommendation
1	726 26	Panel Frame VT180, three level (alternative to 726 25)

Equipment Sets

Complete Lists Including Accessories

T 7.6.1 Wire Antennas and Apertures

T 7.6.1		Wire Antennas and Apertures
Equipment Set		
1	737 01	Gunn Oscillator
1	737 05	PIN Modulator
1	737 06	Isolator
1	737 03	Coax Detector
1	737 12	Waveguide 200 mm
1	737 20	Small Horn Antenna
2	737 21	Large Horn Antenna
1	737 035	Transition Waveguide / Coax
1	737 135	3-Screw Transformer
1	737 390	Set of Microwave Absorbers
1	737 405	Rotating Antenna Platform
1	737 415	Wire Antenna Set
Accessories		
1	301 26	Stand Rod, 25 cm
1	501 02	BNC Cable, 1 m
1	648 07	Storage Tray S24-FN
2	737 15	Support for Waveguide Components
3	648 08	Partition ZW 24
4	301 21	Stand Base MF
1	568 702	Book: Antenna Technology T 7.6
1		Personal Computer with Operating System

Equipment Sets

Complete Lists Including Accessories

T 7.6.2 Reflector-, Helical - and Array Antennas

Equipment Set		
1	737 01	Gunn Oscillator
1	737 05	PIN Modulator
1	737 06	Isolator
1	737 03	Coax Detector
1	737 10	Moveable Short
1	737 12	Waveguide 200 mm
1	737 14	Waveguide Termination
1	737 20	Small Horn Antenna
2	737 21	Large Horn Antenna
1	737 033	Coax Transition male / male N, 50 Ohm
1	737 035	Transition Waveguide / Coax
1	737 135	3-Screw Transformer
1	737 197	E-Bend
1	737 390	Set of Microwave Absorbers
1	737 405	Antenna Rotating Platform
1	737 415	Wire Antenna Set
1	737 424	Slot Antenna
1	737 427	Microstrip Antenna
1	737 440	Helical Antenna Kit
1	737 452	Dish Antenna
Accessories		
1	301 26	Stand Rod, 25 cm
1	501 02	BNC Cable, 1 m
2	737 15	Support for Waveguide Components
2	648 07	Storage Tray S24-FN
4	301 21	Stand Base MF
6	648 08	Partition ZW 24
1	568 702	Book: Antenna Technology T 7.6
1		Personal Computer with Operating System
Recommendation		
1	311 77	Steel Tape Measure, L= 2 m / 78 inch
1	737 16	Frequency Meter
1	737 27	Physics Microwave Accessories I

Equipment Sets

Complete Lists Including Accessories

T 7.6.3 Antenna Measurement Technology

Equipment Set		
1	737 01	Gunn Oscillator
1	737 05	PIN Modulator
1	737 06	Isolator
1	737 09	Variable Attenuator
1	737 12	Waveguide 200 mm
1	737 14	Waveguide Termination
1	737 18	Cross Directional Coupler
1	737 20	Small Horn Antenna
1	737 21	Large Horn Antenna
1	737 29	Waveguide Propagation Accessories
1	737 033	Coax Transition male / male N, 50 Ohm
1	737 035	Transition Waveguide / Coax
1	737 085	DC-Blocker
1	737 135	3-Screw Transformer
1	737 197	E-Bend
1	737 390	Set of Microwave Absorbers
1	737 399	Set of 10 Thumb Screws M4
1	737 405	Rotating Antenna Platform
1	737 424	Slot Antenna
1	737 427	Microstrip Antenna
1	737 440	Helical Antenna Kit
Accessories		
2	737 15	Support for Waveguide Components
1	311 77	Steel Tape Measure, L= 2 m / 78 inch
4	301 21	Stand Base MF
1	301 26	Stand Rod, 25 cm
1	648 07	Storage Tray S24-FN
3	648 08	Partition ZW 24
1	501 02	BNC Cable, 1 m
1	568 702	Book: Antenna Technology T 7.6
1		Personal Computer with Operating System

Equipment Sets

Complete Lists Including Accessories

T 7.6.4 Student Experiments with Antennas

Equipment Set		
1	737 01	Gunn Oscillator
1	737 020	Gunn Power Supply with Amplifier
1	737 03	Coax Detector
1	737 21	Large Horn Antenna
1	737 407	Antenna Stand with Amplifier
1	737 415	Wire Antenna Set
1	737 440	Helical Antenna Kit
Accessories		
1	300 11	Saddle Base
2	501 022	BNC Cable, L = 2 m
1	501 461	Pair Cables, 100 cm, black
1	531 57	Multimeter METRAport 3A
1	648 07	Storage Tray S24-FN
3	648 08	Partition ZW 24
1	501 02	BNC Cable, 1 m
1	568 712	Book: Student Experiments with Antennas T 7.6.4

T 7.7.1 Field Bound EMC Measurements

Equipment Set		
1	737 30	EMC-Trainer
1	568 74EN	Book: Field Bound EMC Measurements
Accessories		
1		Spectrum Analyzer, 1 GHz



Equipment Sets

Complete Lists Including Accessories

Keywords

A-law	13, 37
BORSCHT	10
3-D plotter	111
Absorbers	121
Absorption	72
Adaptive DM	40
Aliasing	36
Amplitude modulation	30
Amplitude shift keying (ASK)	42
Anechoic chamber	121
Antenna gain	114, 118
Antenna technology	65
Antennas	60
Anti clutter gain control (STC)	98
Aperture antenna	110
Array antenna	110
A-Scope	98
A-scope	99
Asynchronous data transmission	37
Attenuation	51
Attenuator π	85
Babinet' duality principle	119
Background noise	98
Binary target extractor	98
Bit error rate (BER)	43
Bit synchronisation	37
Bode plotter	53, 83
Calibration	85
CASSY Lab	6
Cavity resonator	76
Channel crosstalk	32, 36
Channel modeling	46
Circulator	78
Circulator bandwidth	88
Classic radar	98
Clock recovery	40
Clutter	102
Coaxial elements	85
Coaxial lines	45
Coding	36

Keywords

Collision avoidance (TCAS)	102
Collision detection	100
COM3LAB	5
Companding	36
Complex load	77
Complex reflection factor	76
Co-polarization	114
Corner reflector	100
Coupling point matrix	13
Cross-polarization	114
Cross talk	112
Cryptography	60
Cut off wavelength	74
Data recording	11
D-channel protocol	7
Delta modulation (DM)	40
Dialing signal	5
Dielectric line	49
Diffraction	72
Digital interactive monitor	98
Dipole antenna	110, 112
Directional coupler	76
Directional diagram	110
Doppler converter	106
Doppler effect	72
Doppler radar	104
DPCM	36
DTMF signaling	12
Duplex mode	42
Duplexer	101
Duty cycle	98
Dynamic range	99
Echo delay	101
Echo signal	98
E-Field probe	72
Electromagnetic Compatibility (EMC)	65
Equation of motion	104
Error correction	42
Error detection	42
EWSD	6

Keywords

Exchange technology	18
False alarm rate	98
Fan lobe	114
Far end crosstalk (FEXT)	48
Far field condition	99, 110
FFT analysis	12
FFT spectrum	105
Fiber coupler	54
Fiber optics	44
Fire control radar	103
Flexible waveguide	72
Fourier analysis	29
Four wire line	48
Fourier synthesis	29
Frame synchronisation	37
Free space modes	69
Frequency conversion	80
Frequency deviation	34
Frequency domain	13
Frequency measurement	76
Frequency multiplex system	32
Frequency response	53
Frequency shift keying (FSK)	42
Frequency synthesizer	29
FSMA connector	57
Full scan	98
Gain of MMIC amplifier	88
Gaussian minimum shift keying (GMSK)	42
Granular noise	40
Grating lobes	116
Gunn element	72
Gunn oscillator	69
Harmonic oscillations	29
HCS fiber	56
Helical antenna	110
Horizontal diagram	117
Horn antenna	71
Humidity measurement	74
Hybrid circuit	11
Hybrid T	78

Keywords

Independent sidebands	32
Insertion loss	85, 88
Interference	47, 72
IP protocol	11
ISDN	7
ISDN access panel	7
ISDN interface	17
ISDN technology	10
ISO / OSI Model	19
Isolation	86
Isolator	78
IT Technology	45
$\lambda/4$ stub	86
$\lambda/4$ transformer	86
Lecher line	74
LED characteristics	54
Light guidance	54
Line bound telecommunication	18
Line matching	51
Line resonators	86
Line termination	50
Linear delta modulation	40
Lock in amplifier	71
Lock-in measurement	48
Magic T	69, 78
Malus's law	73
Matching	76
Microstrip lines	82
Microwave technology	65
Minimum shift keying (MSK)	42
MMIC technology	83
Modulation index	34
Monostatic pulse radar	101
Motor selector	11
Moveable short	77
MTI simulator	104
Multimeter	11
Multiple echoes	50
Multiple subscriber number	12
Near end crosstalk (NEXT)	48

Keywords

Near field	110
Near field calculator	111
Net management	7
Network analyzer	83
Network termination basic access NTBA	18
Noise	14, 19
Nonreciprocal components	69
NRZ format	40
Object vigilance	98, 104
Optical fibers	11
Optical power	54
Oscillator tuning	80
Oscilloscope	7
PABX	13
PAM spectrum	36
Parabola antenna	91, 110
Parallel plate line	74
Passive targets	101
Pencil beam	114
Phase array	116
Phase shift keying (PSK)	42
Phase shifter	78
PIN diode switch	88
PIN modulator	69, 71, 77, 90
Plain Old Telephone System POTS	18
PMMA fiber	55
Polarization	72
Polarization attenuation	112
Power divider	86
Power transmission	50
PPI	98
Preemphasis	34
Preparation of fiber ends	54
Primary radar	100
Proximity detector	98, 106
Pulse amplitude modulation (PAM)	36
Pulse duration modulation (PDM)	39
Pulse power	100
Pulse radar	98
Pulse time modulation (PTM)	39

Keywords

Pulse train	28
Pulse train frequency	99
Pulses on coaxial lines	50
Quadrature amplitude modulation	32
Quantisation	6
Quantisation linear, non linear	36
Radar	65, 96
Radar beacon	100
Radar cross section (RCS)	100
Radar equation	99
Radar image processor	98
Radar marker	100
Radar targets	100
Range resolution	100
Rat race coupler	86
Reactive elements	86
Rectified signals	28
Reflections	51
Reflectometer	76
Reflexion losses	54
Resistive divider	86
Resonator losses	70
Return loss	85
Return loss of MMIC amplifier	88
RF generator	84
RF high pass	85
RF low pass	85
Ring resonator	87
Rod antennas	88
RZ format	38, 40
S0 bus	13
Sample & Hold	38
Sampling theorem	36, 38
Saw tooth method	38
Secondary lobes	114
Secondary surveillance radar	100
Sector scan	98
Sector scanning	100
Sensor CASSY 2	13, 70
Service characteristics	11

Keywords

Service Features	13
Shift keying	42
Sidebands in normal and inverse position	38
Signal analysis	13
Signal noise ratio (SNR)	42, 46
Signal transmission	90
Signaling	11
Simplex mode	42
Single radiator	113
Slide screw transformer	77
Slope overload	40
Slotted measuring line	77
Smith chart	83
SOLT calibration	85
SPDT switch	89
Spectrum analyzer	45
Speech path allocation	13
Speed measurement	104
Square wave	28
Standing wave	72, 77, 80
Star quad cable	48
Stealth	100, 104
Stop band attenuation	88
Strip line	85
Stubs	86
Subscriber Matching Unit	11
Surface mounted devices (SMD)	85
Switching network	15
Switching system	7
SWR measurement	60
Target detection	98
Target tracking	100
TE waves	74
Telecommunication lines	45
Telematics	60
Telemetry	60
Telemobiloscope	97
Telephone technology	17
TEM waves	74
Time division multiplex	4, 36

Keywords

Time domain	15
Traffic nodes	11
Training panel system	10
Transimpedance amplifier	54
Transmission channel	47
Transponder	100
Triple antenna method	118
Trunk exchange	7
UHF components	69
Undesired modes	54
Unidirectional line	71
Variable range marker (VRM)	98
Velocity time diagram	105
Vertical diagram	117
Visibility	100
Voice signal	19
VoIP	20
Waveguide flange	66
Waveguide modes	69
Wavelength measurement	76
Wilkinson divider	86
Wire antennas	113
Wireless data transmission	61
X-band	69
XY plotter	20
Yagi antenna	110, 112



LD DIDACTIC GMBH

Leyboldstraße 1

D- 50354 Hürth

Tel.: +49(0)2233- 604-0

Fax: +49(0)2233- 604-222

E-Mail: info@ld-didactic.de

www.ld-didactic.com

WWW.LD-DIDACTIC.COM